

TRANSIT DESIGN GUIDELINES



ACKNOWLEDGEMENTS

WeGo Public Transit provides public transportation throughout the Nashville metropolitan area.

WeGo operates with the support of personnel employed by the Davidson Transit Organization.

WeGo is governed by a five-member Board of Directors. The Board holds a monthly public meeting.

WeGo's budget is funded by fare and advertising revenue along with money from the state and local governments.

WeGo Public Transit began providing service in 1973 as the Metropolitan Transit Authority after the purchase of the Nashville Transit Company by the Metropolitan Government of Nashville and Davidson County.

PARTICIPANTS

These guidelines were developed by WeGo staff in collaboration with CDM Smith. Maps and graphics were created by WeGo and CDM Smith.

Completed in collaboration with the Metropolitan Government of Nashville and Davidson County, Walk-Bike Nashville, Tennessee Department of Transportation, and Nashville Area MPO.

Published February 2019



CONTENTS

1. INTRODUCTION			
Why This Document	6	Car Share Spots	66
System Map	7	Electric Vehicle Charging Stations	67
How to Use This Document	8	Bus Charging Stations	68
WeGo Service and Network Integration	9	Park & Ride	69
Stop Typology	10	Van Pool Space	70
		Passenger Pick-Up & Drop-Off	71
		Taxi / Ride Share Company Waiting Area	72
		Supplemental Bus Parking	73
2. BUS STOP DESIGN			
Universal Design and ADA Accessibility	14		
Bus Stop Spacing	16	4. TRANSIT CENTERS	
Bus Stop Types	17	Neighborhood Transit Centers	76
Bus Stop Placement	21	Transit Centers - Expanded Sites	80
Driveways and Intersection Sight Distance	25		
Stop Design Alternatives	26		
Bicycle Lane Considerations	30		
3. AMENITIES			
Guiding Principles	38	Appendix A - Reference Material	
Approach	42	Appendix B - Standard Drawing Plates	
Matrix	43	Figures	
Bus Stop Signs	44	1 - WeGo System Map	7
Benches	45	2 - Sign Stop	17
Trash Receptacles	46	3 - Bench Stop	18
Bicycle Racks	47	4 - Shelter Stop	19
Shelters	48	5 - Rapid Stop	20
Site Lighting	49	6 - Stop Placement	21
Next Bus Signs	50	7 - Driveway Arrangements	25
System Maps and Timetables	51	8 - Bus Bulb Stop	27
Integrated Advertisements	52	9 - Curbside Stop with Cycle Lane	31
Canopies	53	10 - Curbside Raised Cycle Lane	31
Local Area Maps / Wayfinding	54	11 - Shared Space Scenario	32
Ticket Vending	55	12 - Separate Space Scenario	33
Bicycle Lockers	56	13 - Island Stop	34
Surveillance Cameras	57	14 - Basic Neighborhood Transit Center	77
Call Box / Emergency Buttons	58	15 - Sawtooth Layout	79
Climate Controlled Waiting Areas	59		
Employee Restrooms	60	Tables	
WiFi	60	1 - Guidelines for Bus Stop Spacing	16
Vendor Space	61	2 - Stop Placement	22
Bollards	62	3 - Platform Length	23
Landscaping	63	4 - Loading Positions	23
Public Art and Placemaking	64	5 - Preferred Placement	24
Shared Mobility	65	6 - Comparative Assessment (Stop Types)	29
		7 - Stop Types Summary	30
		8 - Comparative Assessment (Bike Lanes)	35
		9 - Amenities by Stop Type	43
		10 - Transit Center Essentials	77
		11 - Smaller Transit Center Optional Amenities	77
		12 - Larger Transit Center Optional Amenities	80



NASHVILLE

80

5th Ave S

Southbound

1. INTRODUCTION



WHY THIS DOCUMENT

WeGo Public Transit (WeGo) is committed to delivering outstanding transportation service to residents and visitors of Nashville, and to ensure accessibility for riders regardless of age or disability. This document supports this goal by providing guidelines for the design and placement of transit facilities and their associated passenger amenities. These guidelines represent the culmination of research into best practices of other transit agencies; input from WeGo staff, Metropolitan Government of Nashville-Davidson County (Metro Nashville), Walk-Bike Nashville, TDOT, and the Nashville Area MPO; evaluation of existing conditions; and the foundation laid by WeGo's existing standards.

The guidelines in this manual are intended to be applied to the design, construction and modification of transit facilities located within Metro Nashville. This is to ensure that all new, relocated, and modified transit facilities meet minimum standards and comply with respective ADA requirements.

This manual should help coordinate WeGo priorities with other agencies, developers, and designers to create consistent, well-designed transit facilities that meet the standards of Metro Nashville, the State of Tennessee and the Americans with Disabilities Act (ADA). The general public may also find these guidelines useful in understanding the current practices for the placement of transit facilities.

The manual provides a guide to understanding WeGo's system, including the basic philosophies and service standards. Chapter 1 provides an overview of WeGo's existing system and the elements that factor into stop design. Chapter 2 defines the principles and procedures for establishing bus stop infrastructure and incorporating ADA access requirements. Chapter 3 defines the various amenities that can be incorporated into a stop to make the stop more comfortable and efficient for the rider. Chapter 4 returns to the principles defined in Chapters 2 and 3 and applies them to larger Neighborhood Transit Centers. Understanding these components will allow for a cohesive, efficient system that will be beneficial to the community as a whole.

The guidelines presented in this manual are intended to supplement existing engineering, design and environmental standards and requirements of the federal, state and local municipalities in which the transit facility is located. The design of any transit facility shall be fully compliant with all applicable laws, rules, regulations and codes. Nothing written or illustrated in this manual should be construed as a waiver of any applicable law, rule, regulation or code, nor does it relieve the designer or developer of the responsibility to verify the compliance of their designs.

Bus System & Components Overview

WeGo offers several types of bus services via more than 40 fixed routes within Davidson County. It also offers door-to-door paratransit service for people with disabilities who are unable to ride the fixed-route buses and two free downtown circulators with connections to attractions and businesses. Central, the hub for bus service, is located on Martin Luther King Jr. Boulevard between 4th Avenue North and 5th Avenue North in Nashville's Central Business District and serves as the main transfer point. It contains 24 bays on two levels, a parking garage, public restrooms, and a staffed Customer Care Center with information and ticket sales.

WeGo's system map is provided in **Figure 1**.

SYSTEM MAP

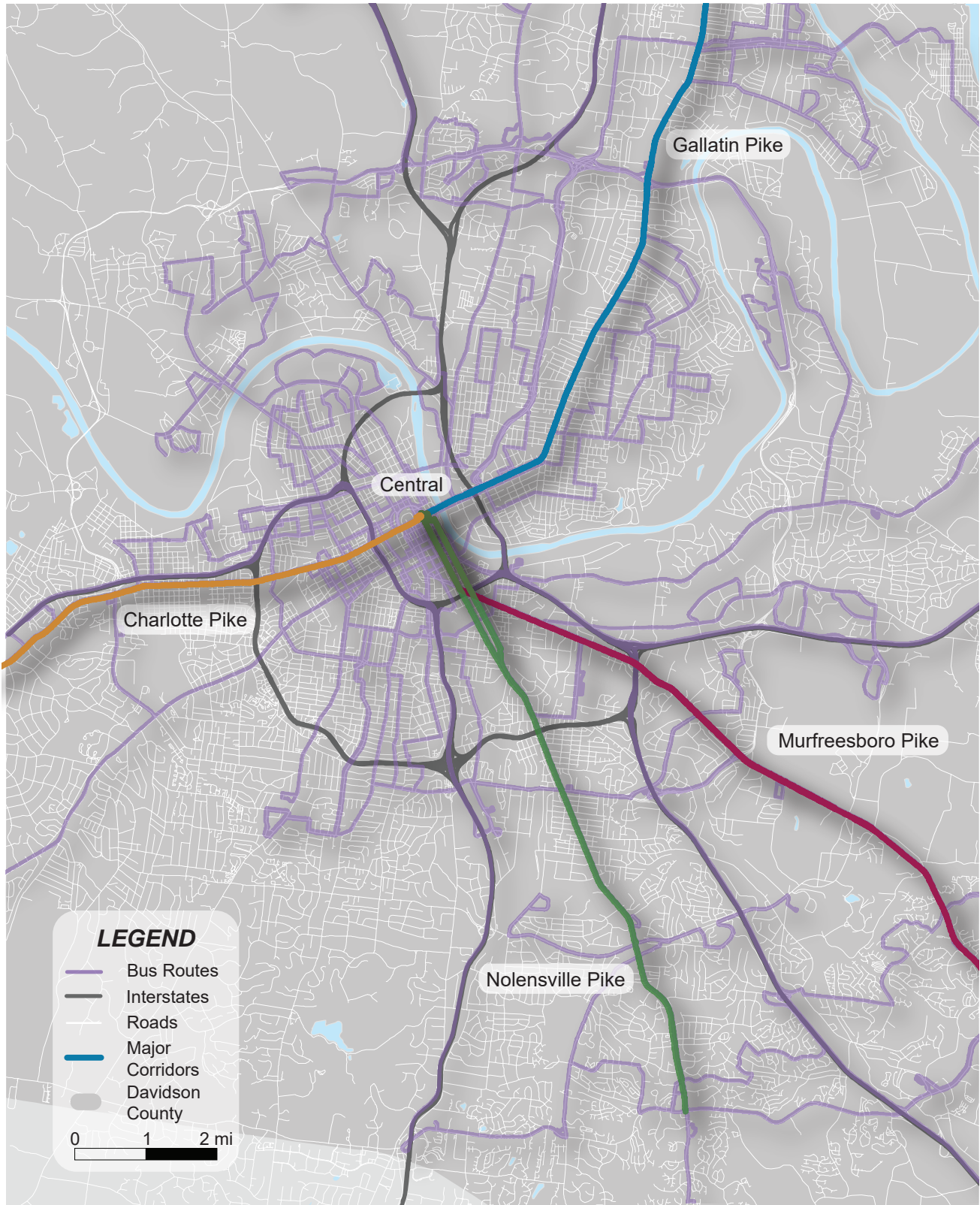

Figure 1 - WeGo System Map

HOW TO USE THIS DOCUMENT

This document is intended to guide WeGo staff and their consultants in designing bus stops that are appropriate for the service being provided and serve as a collection of the standards WeGo requires in the design of its stops. Multiple combinations of stop type paired with service type are possible, but funding and space limitations make it important to design a stop that maximizes the impact and cost-effectiveness of the investment in the stop. Below is a set of guidelines for using this document to make the most of a design.

1. IDENTIFY SERVICE TYPE & VEHICLE

It is important to identify the service type, design vehicle and expected or existing ridership because these elements are essential in determining the correct level of stop and design attributes.

2. DETERMINE STOP SPACING & PLACEMENT

Utilize the guidelines to determine stop spacing and placement, especially on corridors with multiple service routes or poor access management. Site conditions will vary, and the guidelines provide criteria to achieve efficient service conditions within the context of the surrounding land use.

3. DETERMINE STOP TYPE

It is important to determine the appropriate stop type based on service type and site context. While the placement of a stop determines to a large extent how transit passengers gain access to transit service, the design and configuration of stops and stations impacts how everyone on the street interacts with the transit system and has a large impact on the perception of the system and service.

4. MEET ALL CODES & STANDARDS

Always reference the most recent guidelines for ADA accessibility and design. WeGo must adhere to federal, state, and local requirements in the design of its stops.

5. APPLY GUIDELINES

Apply the amenities guidelines to select the appropriate vendors and materials for station elements. This document should be used as a resource for determining the standard materials that are used in WeGo bus stops so that stops are consistent and familiar to the customer. Safety and accessibility are also improved by using standard features.



WeGo Service



WeGo Service at Transit Center

WeGo SERVICE and NETWORK INTEGRATION

Bus service can be broken into categories based on the frequency of service and the organization of the routes. WeGo's bus system is comprised of four fixed-route service types as well as link to other means of mobility:

WeGo LOCAL SERVICE

Local service balances access with speed, providing basic and reliable service for neighborhoods. Stops are ideally spaced every 1/4 mile and provide connections to higher frequency routes.

WeGo EXPRESS SERVICE

Express service is typically composed of longer routes with fewer stops, connecting residential areas with activity centers. Express services typically travel on limited access roadways with higher speeds and include connections to park & ride lots.

WeGo RAPID SERVICE

Rapid Service consists of high frequency, high density routes on heavily travelled corridors. Current Rapid Service exists on Charlotte Pike, Gallatin Pike, Murfreesboro Pike, and Nolensville Pike. Stops are typically spaced every 1/3 mile.

WeGo CIRCUIT SERVICE

Circuit service provides frequent service within high density areas such as downtown and other civic insitutional areas.

COMMUNITY MOBILITY

As the transportation network changes into the future, WeGo will be working to keep bus service integrated with alternative modes of transportation to help create a cohesive transportation network. Service and stops will need to continue to be designed for the communities that use bus transit while also appealing to new user groups.



WeGo Service Objectives

STOP TYPOLOGY

STOP TYPOLOGY

WeGo utilizes three configurations of bus stop: local, rapid, and transit centers. Each configuration represents a specific level of service with differences in the standard amenities, operation, and philosophy. All stop types will incorporate ADA requirements regarding boarding and alighting areas as well as accessible routes to sidewalks and pedestrian paths to create the foundation of a connected mobility network. Each type is described in more detail below.

LOCAL SERVICE STOP

Local service balances the accessibility of the system with speed of service. This means providing multiple access points for a route at convenient locations to find a strategic equilibrium between capturing riders and providing reasonable travel times. Local service stops are an essential component of each service type, including rapid service when appropriate. Routes can be linear, circular, or networked, depending on the desired balance between having direct service or greater coverage. It is typically applied on local streets with lower speeds and as few as two lanes.

Local service stops are located on the street and incorporated into the surrounding land use. There are three levels of stop type under local service: sign stops, bench stops, and shelter stops. Amenities can consist of the standard sign and a level, paved boarding area at a sign stop, and can be improved by adding benches, shelters, lighting, service maps/schedules, trash cans, and bicycle racks. Addition of these amenities is based on space, ridership, and funding.

RAPID SERVICE STOP

Rapid bus service is focused on fewer stops across longer linear corridors to provide faster and more convenient service between residential areas and activity centers. Rapid service is typically applied on roadways with more lanes and higher speeds and may include connections to park & ride lots at terminal points.

Rapid service stops are located on the street but, unlike local stops, are intended to be uniquely identifiable and highly visible to call attention to the level and quality of service provided. Rapid service stops offer more amenities, such as real-time arrival displays, compared to local service because they are intended for higher ridership with frequency of service on larger corridors. A basic rapid service stop consists of a paved boarding area meeting ADA requirements, and is large enough to accommodate a shelter with a bench, a trash can, shelter lighting, and bike rack if appropriate.

TRANSIT CENTER

Transit centers are major facilities that are designed to be a multimodal focal point of transportation. They are typically applied as a junction between local service, rapid service, and other modes of transportation at layover stops or transfer points, and can be a mixture of on street stops and internal bus bays depending on the types of routes served. Transit centers are destination points that can serve as a transportation hub by including connections to park & ride lots, electric vehicle charging, car share and bikeshare services, and paratransit service.

Though they are larger than a local or rapid service stop, their size and scale can vary depending on passenger volume, the number of routes servicing the stop, and space availability. A basic transit center will be at the convergence of at least two routes and will consist of a paved boarding area meeting ADA requirements and a larger refuge area than a typical bus stop. Standard amenities include canopies, lighting, trash cans, bike racks and lockers, system maps and information, ticketing kiosks, and real-time service displays. As the size of the center increases with the number of routes, additional amenities may be added such as passenger drop-off areas, restrooms, bike share, Wi-Fi capability, and public art.

STOP TYPOLOGY

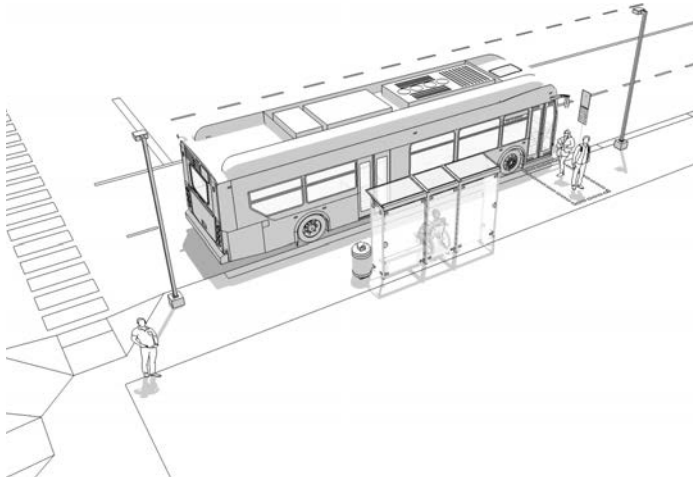

Local Bus Stop

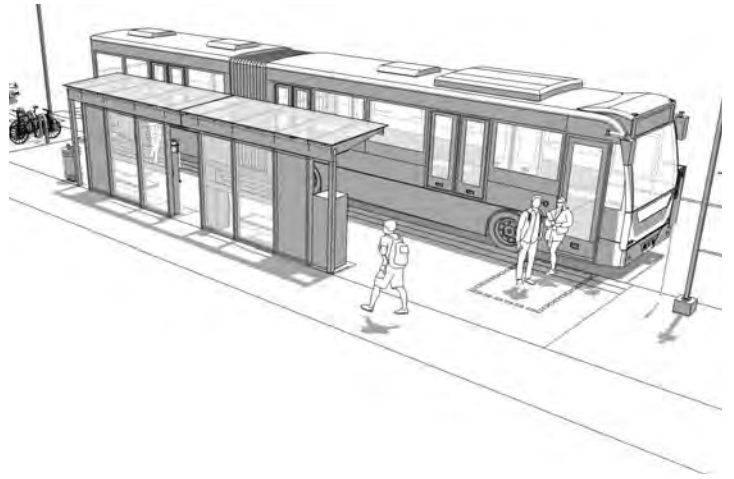

Rapid Service Stop

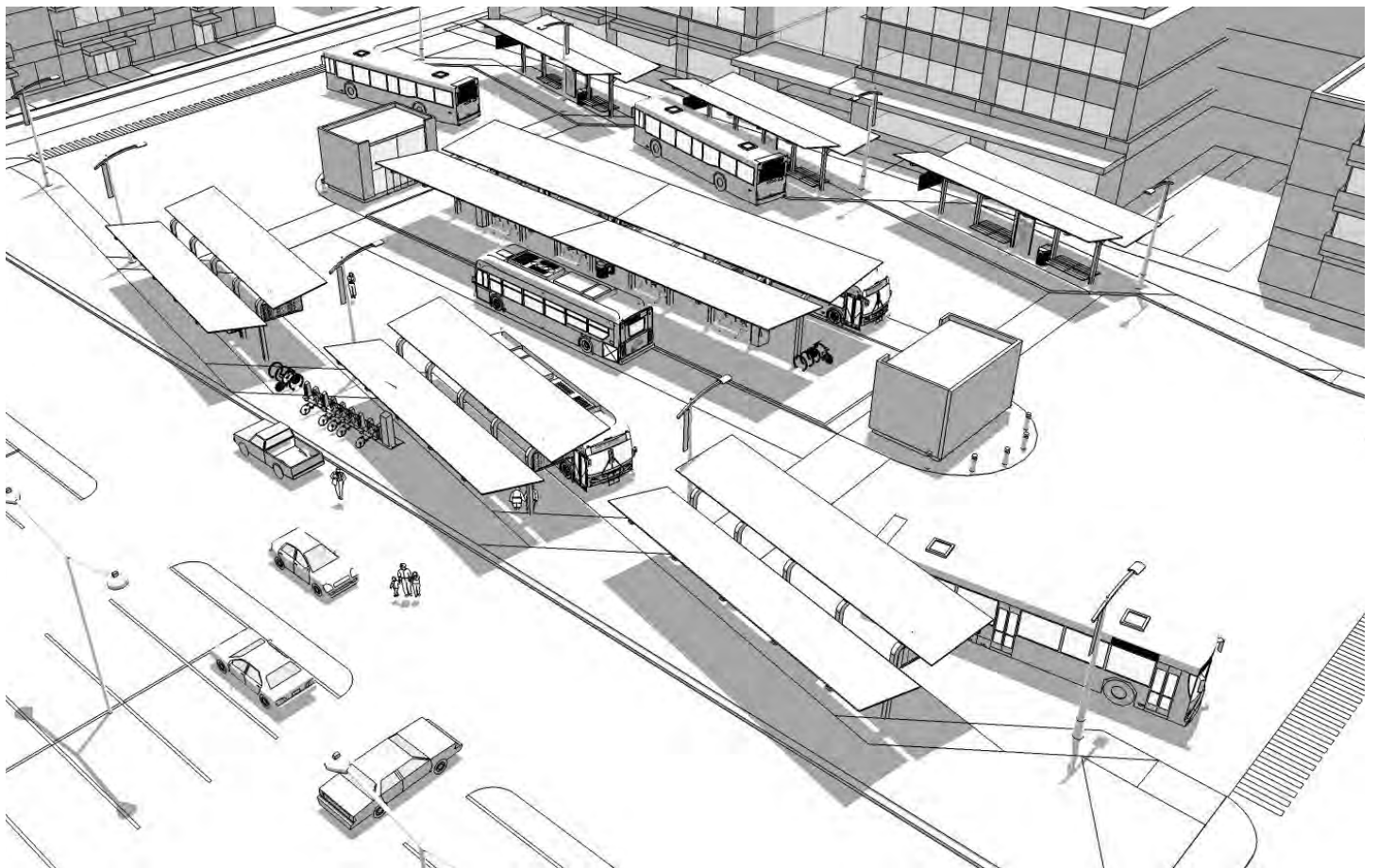

Transit Center



5

WARRIORS

2. BUS STOP DESIGN



UNIVERSAL DESIGN and ADA ACCESSIBILITY

This chapter contains recommended steps and guidelines for locating and designing bus stops. Further guidance is provided on effectively spacing and locating bus stops as well as principles to consider when configuring a stop.

UNIVERSAL DESIGN and ADA ACCESSIBILITY

When designing stops, it is important to consider usability and equity. These two core components are incorporated through universal design elements and accessibility standards, which ensure that the system is familiar at every point a customer accesses it and that it is accessible to anyone that wishes to use it. Universal design also makes the system easier to use because the design elements are reinforced through repetition, making the communication of system information easier and reducing the cost of maintenance by making components interchangeable across the system.

Before beginning any bus stop design, the responsible party should review the most current applicable ADA Standards for Accessible Design, as well as transit agency, local, state and federal guidelines that may impact accessibility or universal design elements.

ACCESSIBILITY

Boarding Areas

Bus stops should be located to allow safe and convenient ingress and egress for passengers at all bus doors. Designers need to consider all buses in Nashville WeGo's fleet that would typically be assigned to that route. In addition, ADA standards require a 5' x 8' accessible landing pad for passengers.

Accessible Routes and Connectivity

It is important to maintain connectivity to bus stops through clearly defined paths between the stop and pedestrian destinations. Ideally, sidewalks are already present on streets with bus stops, but there may be cases where the stop needs to be connected via a path. ADA guidelines also require that the ADA accessible landing pad must be connected to the street, sidewalk, or other pedestrian path via an accessible route.

Clear Space

Clear space around stop elements like shelters and benches is important for allowing pedestrians to safely walk around the stop. Narrow paths or misplaced amenities can create pinch points that reduce pedestrian flow and make the stop uncomfortable. They also may restrict access for passengers with disabilities, especially those in wheelchairs. Bus stop and pedestrian path of travel standards from the Major & Collector Street Plan should be adhered to; any proposed modification to the standards should be coordinated and approved by Metro Public Works and Metro Planning. In addition, companion space next to benches and within shelters is an important consideration for those accessing the transit system via wheelchair. The latest ADA guidelines regarding clear space and companion space should be referenced for any shelter or enclosed area at a bus stop or transit center.

Signs, Maps and Elements of Communication

It is important that passengers be able to clearly identify bus stops via signage. WeGo utilizes templates to outline the design and layout of all signs at a bus stop including stop identification, schedules, timetables, and system maps and are discussed further in Chapter 3 of this document. The design and layout of all signs at bus facilities including stop identification, schedules, timetables, and system maps should follow the most up-to-date WeGo templates.

UNIVERSAL DESIGN

Detectable Warning Strips

Detectable warning strips are a tactile device installed on walking surfaces to warn visually-impaired pedestrians of hazards when they are leaving a pedestrian area. They consist of a slip resistant surface with raised domes that provide a tangible distinction from the pedestrian walkway and are used to indicate a boundary between pedestrian-only paths and paths for other modes of travel. They should be used when pedestrian routes cross or transition into other modes via a flush rather than a curbed transition, such as a curb ramp leading to a pedestrian crosswalk at an intersection or a shared path between bicycles and pedestrians.

UNIVERSAL DESIGN and ADA ACCESSIBILITY

Lighting

The use of lighting at bus stops not only makes the system usable during non-daylight hours but also adds security by increasing visibility. The type and context of a stop as well as existing lighting should first be looked at before considering lighting options. When lighting is added to a stop, care should be taken so that the transition from darkness to light is not too abrupt. Considering this transition will ease the adjustment of eyesight and prevent the creation of a light halo that can negatively affect nighttime visibility.



Tactile warning



Bus stop lighting

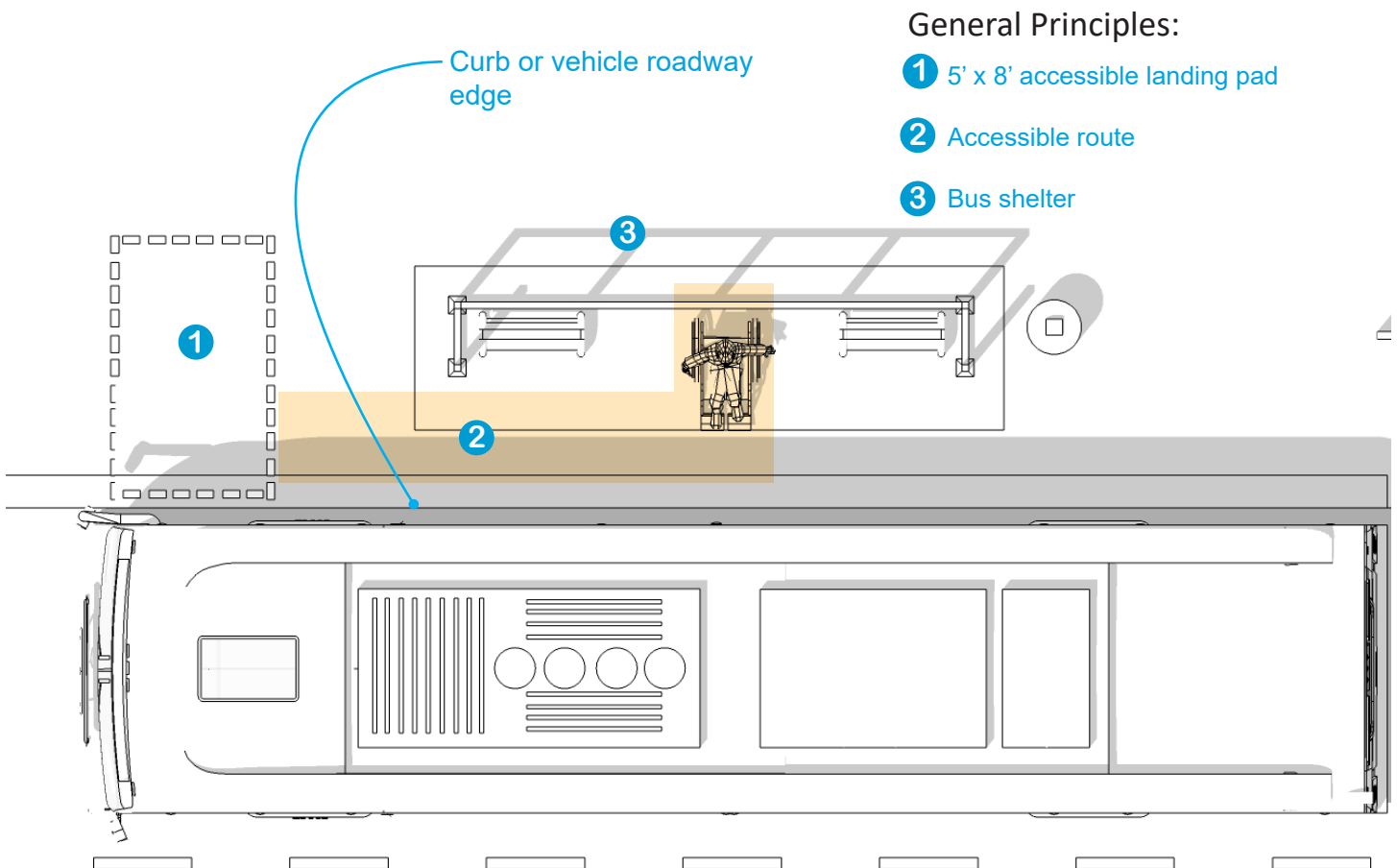

ADA bus stop

BUS STOP SPACING

The spacing of bus stops impacts travel time and system performance and involves trade-offs. Efficient bus stop spacing balances the goal of minimizing travel time for the bus and walking distance for the passenger. This section provides guidance to inform the spacing of bus stops.

GUIDING PRINCIPLES

Stop spacing is an important tool in achieving operational performance and service coverage goals. When stops are uniformly placed, passengers can more easily understand the layout of the system and rely less on maps and guides. In general, bus stop spacing should adhere to the following principles:

Land Use Type and Population Density

Stops should be located near areas of high population density or activity. This typically means shorter spacing between stops in core areas of cities and increased spacing as land-use becomes less dense and more spread out. Certain types of land use present unique circumstances for stop consideration when they are outside of dense urban environments, including:

- Major employment and/or retail centers
- Education centers
- Major medical facilities with out-patient care
- Housing developments accommodating senior citizens or persons with disabilities
- Popular recreational areas

Stop spacing for these types of land use and activity centers may deviate from the preferred spacing based on consideration of the route type and expected ridership. Exceptions should be kept to a minimum in order to ensure that routes operate as efficiently as possible and provide reliable service to passengers.

Route Interconnectivity

Stops should be strategically placed at transfer points where routes overlap in order to enhance coordination in the network. When nearby routes don't overlap, stop spacing should be adjusted to take into consideration the shortest path between nearby bus routes

GUIDELINES

WeGo has developed general spacing standards based on the type of service and nearby land use as outlined below:

- Local service stops serve as moderately spaced stops to connect passengers to frequent service. This stop type is designed with neighborhoods as a focus, with routes that may serve less congested areas.
- Rapid service stops are spaced closer together to allow for easier connections to the frequent service that serves the stops. These stops serve dense, mixed-use areas along major corridors in the region.
- Express service stops are intended to serve a purpose on the regional level, with distant service areas focused on park & rides.
- Circulator service stops serve downtown and popular destinations with convenient stop locations placed close-by along routes.

Table 1 outlines WeGo's recommended spacing for bus stops. While these are recommended there are unique conditions that may require exceptions. Closer stops may be needed to provide access to highly utilized facilities such as government buildings, senior centers and healthcare facilities, or stops may be further apart due to considerations such as sparse development, operating needs, or unsafe roadside conditions.

Table 1 - Guidelines for Bus Stop Spacing

Service Type	Stop Distance
Local	¼ Mile
Rapid	⅓ Mile
Express	Wide spacing based on park & rides
Circulator	Key landmarks and destinations

BUS STOP TYPES - SIGN

WeGo uses four types of bus stop for its service routes and utilizes transit centers for multimodal transit nodes. Stop type is driven primarily by the level and type of ridership in an effort to maximize the cost-effectiveness of the investment in amenities and infrastructure. Stops with higher ridership or a larger number of youth, senior, or disabled passengers may incorporate amenities such as shelters, benches, and bike racks. Stops with lower ridership may simply have a sign indicating the stop.

The four types of stop are described below with corresponding examples and guidelines for their application. Transit centers are discussed in Chapter 4 of this document.

SIGN STOPS

Sign stops include only two components, a sign indicating where the front of the bus stops and an ADA accessible landing surface connected to a pathway. An example is shown in **Figure 2**.

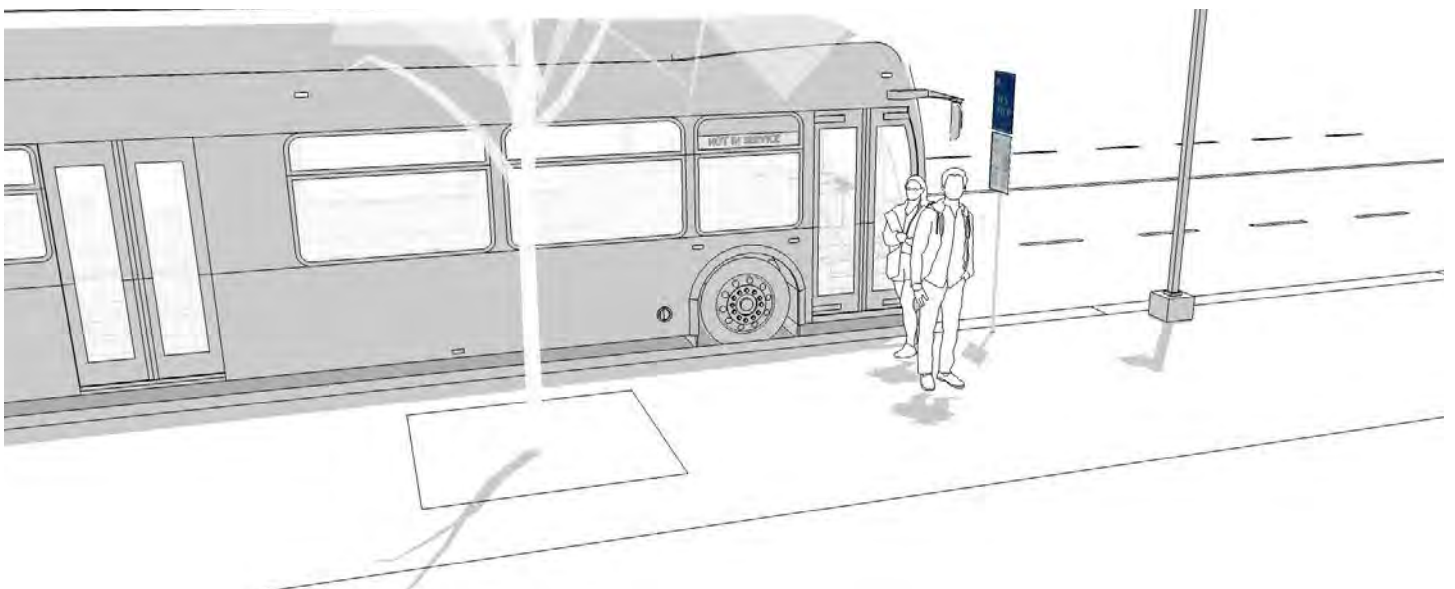

Figure 2 - Sign Stop

GUIDELINES

The following guidelines should be used to guide the design of a sign stop:

- Sign placement should adhere to the guidance provided. Signs should be placed 2' from the 5' x 8' clear landing area and 2' from the face of the curb to prevent being struck by the mirror of the bus. The edge of any sign below 7' should be placed outside of the 5' clear pedestrian walkway required by Metro Public Works.
- The bus stop sign should be located at the front of each bus zone as the bus driver will align the front of the bus with the sign.
- The bus stop sign should be on an independent post, separate from other signage.
- The bus stop sign must be clearly visible to the approaching bus driver and should neither block nor be blocked by other jurisdictional signs or other obstructions.
- Sign locations should be coordinated with existing street lights and security cameras when possible to increase visibility and enhance security at the stop.

BUS STOP TYPES - BENCH

BENCH STOP

Bench stops are used at locations that serve over 25 riders boarding daily, locations that incur long wait times, or locations that are likely to attract riders with difficulty walking or standing. A bench stop includes the components of a sign stop with the addition of a bench and may also include trash cans as shown in **Figure 3**. ADA standards related to bench stops can be found in **Appendix A**.

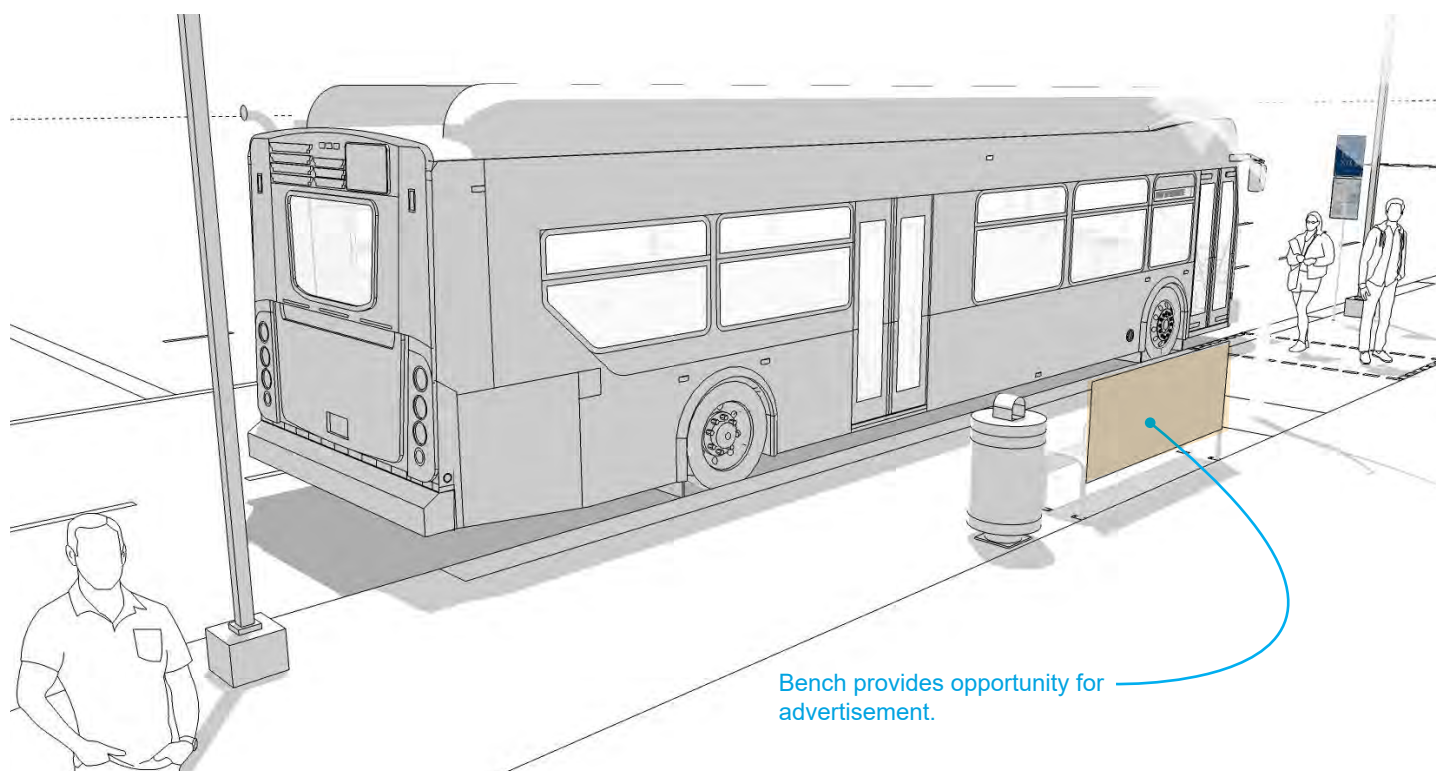

Figure 3 - Bench Stop

GUIDELINES

Bench stops should follow the guidelines for signs noted in the previous section, with the addition of the following guidelines:

- Benches should incorporate backs and companion seating areas per ADA standards.
- Bus stop and pedestrian path of travel standards from the Major & Collector Street Plan should be adhered to; any proposed modification to the standards should be coordinated and approved by Metro Public Works and Metro Planning.
- The bench should be installed adjacent to (but not impeding) the ADA landing area and connected to a pedestrian pathway.
- Benches and other stop elements should be located outside of a minimum 10-foot radius around a Nashville Electric Service pole for a fall safe zone.
- Locate benches away from driveways to enhance patron safety and comfort.
- Coordinate bench locations with existing shade if possible to avoid direct exposure to heat and sun, which can discourage use of the bench.

BUS STOP TYPES - SHELTER

SHELTER STOP

Shelter stops should be applied where possible at locations that serve over 25 riders boarding daily, transfer points, stops in weather-exposed locations without nearby shelter, and stops with a relatively high use by senior and child passengers. Shelter stops incorporate the elements of sign and bench stops with the addition of a partially closed waiting area. Shelters can significantly improve the perception of wait time and customer satisfaction. ADA standards related to shelter stops can be found in **Appendix A**.

Shelter stops may incorporate additional elements such as bike racks, route maps, trash cans and advertisements depending on site or service needs. An example of a shelter stop is shown in **Figure 4**.

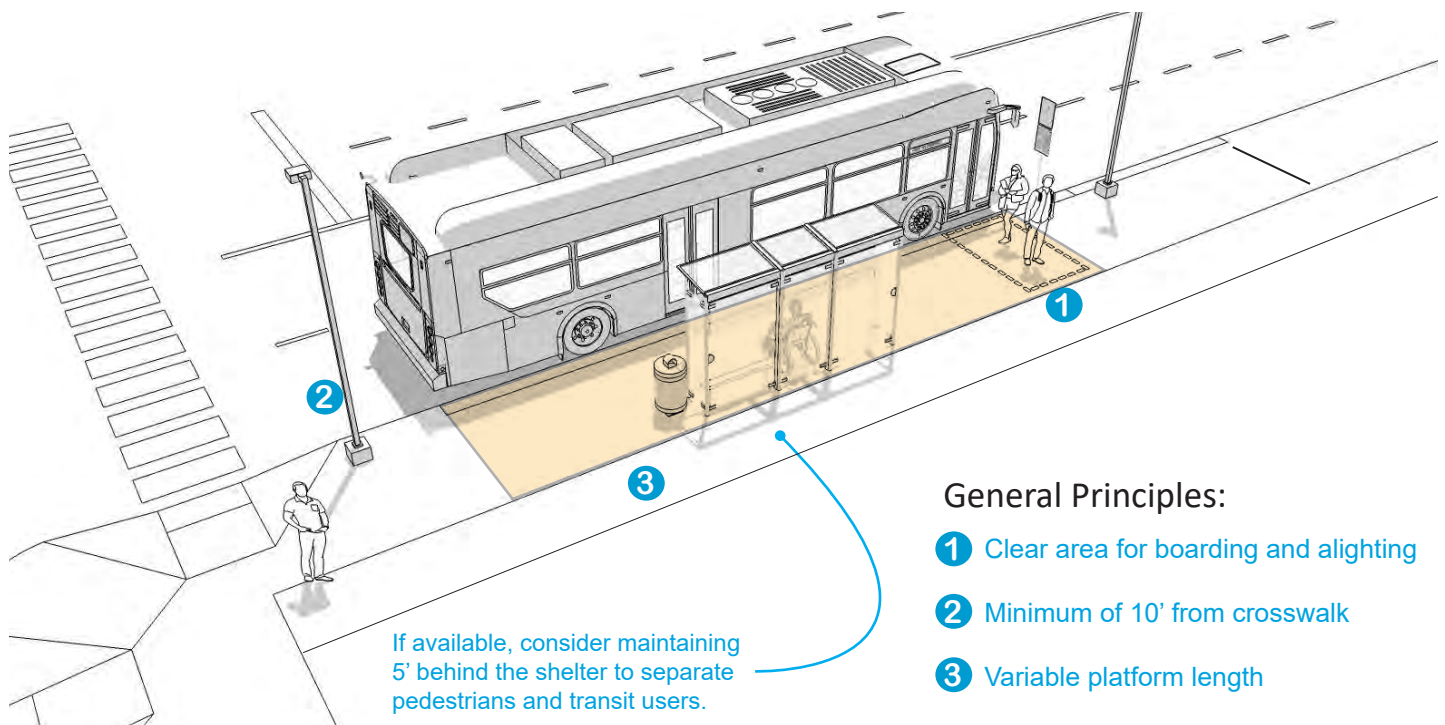

Figure 4 - Shelter Stop

GUIDELINES

Shelter stops should include the guidelines for signs and benches noted in the previous sections, with the addition of the following guidelines:

- The 5' x 8' ADA accessible landing pad may be located within or outside the shelter.
- Shelters must not be more than 15' from the ADA landing pad.
- Shelters must not be located within 15' of a fire hydrant or handicap parking space.
- A minimum clearance of 2' between the shelter roof and curb face is required to prevent it from being struck by mirrors.

BUS STOP TYPES - RAPID

RAPID SERVICE STOP

Rapid service stops are used on WeGo Rapid service routes and are intended to provide a highly visible, substantial physical presence on the street to call attention to the level and quality of service provided. They are similar to shelter stops, though the shelter and boarding area are typically larger when space is available. WeGo's rapid service shelters are a minimum of 12' with a boarding area to accommodate a 60' bus and may include route diagrams, benches, and trash cans. Stops with more than 50 passenger boardings per weekday will be prioritized for real time arrivals information, and bike racks may be included when located near appropriate bicycle infrastructure. The designer of a rapid service stop should refer to Chapter 3 of this document for design elements related to possible amenities. An example of a rapid service shelter stop is shown in **Figure 5** with additional information related to ADA standards in **Appendix A**.

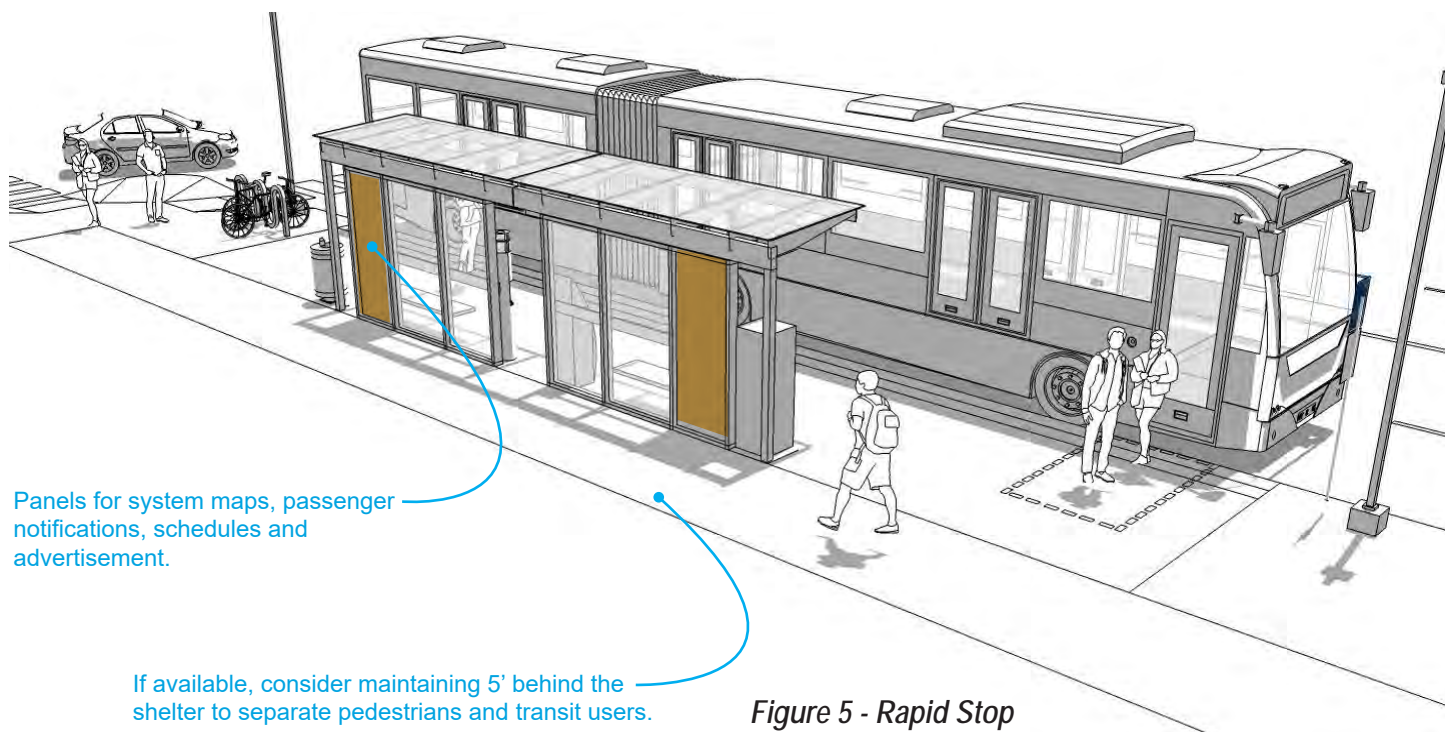

Figure 5 - Rapid Stop

GUIDELINES

Guidelines for the design of a rapid service stop should adhere to the same guidelines as shelter stops, with the exception that rapid service shelters will require a larger site footprint because they include certain standard amenities. To incorporate these standard amenities, the site for the placement of a rapid service stop may be modified to alternative configurations that provide space to fully apply the stop standards. Configuration alternatives for rapid service stops are discussed in more detail later in this chapter in the Stop Design Alternatives section.

BUS STOP PLACEMENT

WeGo bus stops should be located at intersections to provide safe access to crosswalks and improve the connectivity to intersecting bus routes. Stops may be placed before the intersection (near-side) or after a bus crosses an intersection (far-side). Under certain situations, bus stops may also be placed at mid-block locations away from intersections. These three types are illustrated in Figure 6.

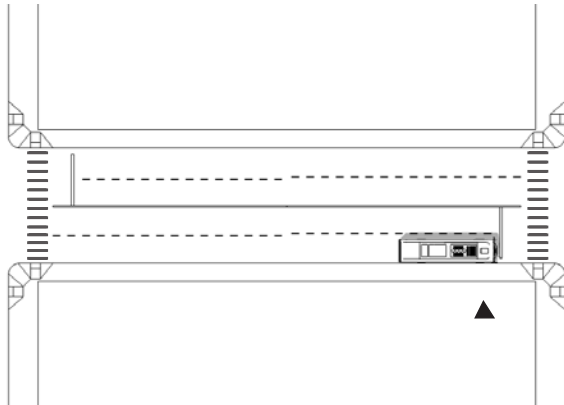

Near-Side Bus Stop

Bus stops before entering the intersection

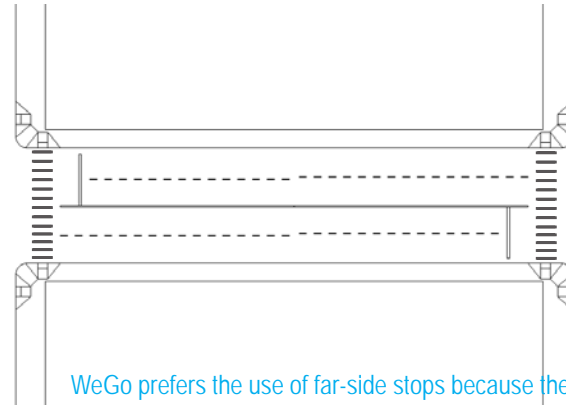

WeGo prefers the use of far-side stops because they reduce conflicting interactions with other vehicles and encourage passengers to cross at the intersection behind the bus, improving their visibility to oncoming traffic. Each location has its advantages and disadvantages, which are highlighted in Table 2.

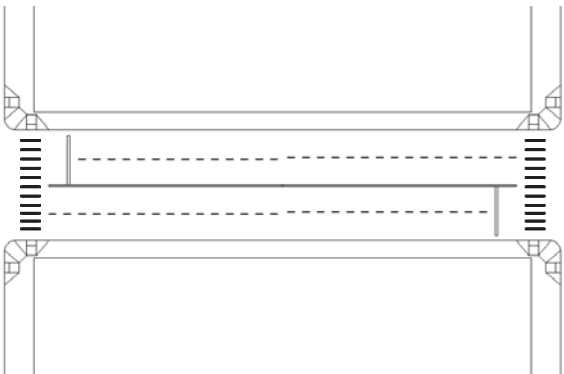

Far-Side Bus Stop

Bus stops after going through intersection

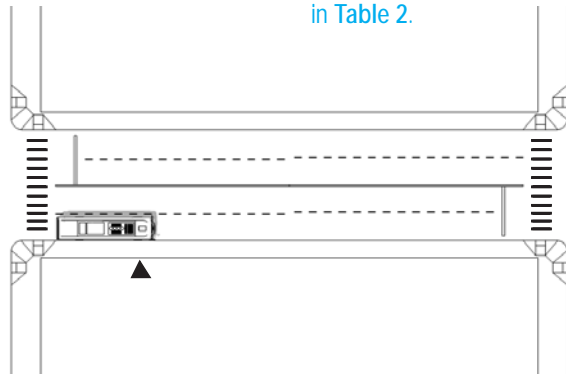

Mid-Block Bus Stop

Bus stops in the middle of the block. Undesirable and should only be considered in limited applications.

"Bus stops may be placed at midblock locations on long blocks or to serve a major transit generator. At midblock bus stops, crosswalks should be considered based on pedestrian and bicycle access patterns."
-TDOT Multimodal Guidelines (9-705.00)

Figure 6 - Stop Placement

BUS STOP PLACEMENT

Table 2 - Stop Placement

Type	Advantages	Disadvantages
Far-Side (Preferred)	<ul style="list-style-type: none"> • Minimizes conflicts between right turning vehicles and buses • Provides additional right turn capacity (because bus is not stopped in lane) • Encourages pedestrians to cross behind bus • Creates shorter deceleration distances for buses since the bus can use the intersection to decelerate • Bus can re-enter traffic via gaps in traffic flow created at signalized intersections • Minimizes sight distance issues on approach to intersection 	<ul style="list-style-type: none"> • Could result in traffic queued into intersection when bus is stopped in travel lane • May obscure sight distance for crossing vehicles • May cause sight distance problems for pedestrians crossing from behind the bus in the same direction of travel • Potential for double stopping – stopping for signal and then at stop • May increase rear-end accidents if drivers do not anticipate the bus stopping after the intersection
Near-Side	<ul style="list-style-type: none"> • Minimizes potential for “gridlock” when traffic is heavy on the far side of the intersection • Allows passengers to access closest crosswalk • Driver has width of intersection to pull away from curb • Eliminates the potential of double stopping – stopping for passengers and stopping for traffic signal • Allows passengers to board and alight while bus is stopped at red light 	<ul style="list-style-type: none"> • Increases conflict with right turning vehicles • May result in stopped buses obscuring curbside traffic control devices and crossing pedestrians • May block through lanes during peak period with queuing buses • May introduce sight distance problems for pedestrians and motorists • Vehicles may attempt to turn in front of a stopped bus that is beginning to pull away • Pedestrians may try to cross in front of the bus at an unsignalized or mid-block crosswalk
Mid-Block (Undesirable and Should Only Be Considered in Limited Applications)	<ul style="list-style-type: none"> • Minimizes sight distance problems for vehicles and pedestrians • May result in passenger waiting areas experiencing less pedestrian congestion • Reduces influence of congestion at intersections 	<ul style="list-style-type: none"> • Requires additional distance for no-parking restrictions • Encourages patrons to cross street at mid-block • Increases walk distance for patrons to reach intersection crossing • Interrupts traffic flow

BUS STOP PLACEMENT

CUSTOMER SAFETY

Stops should ultimately be located at safe crossing locations or have access to safe crossings. To improve safety, near-side stops should be avoided at unsignalized or mid-block crosswalks to prevent pedestrians from crossing in front of the bus. The relative safety of any potential site should be considered, with WeGo maintaining the ability to adjust stop spacing.

VISIBILITY

Bus stops should not be located over the crest of a hill, immediately after a road curve to the right, or at other locations that limit the visibility of the stopped bus to oncoming traffic. Stops should also be placed in areas that are easily identifiable by passengers and allow clear visibility between waiting passengers and the bus driver. Locating stops near major trip generators should increase the visibility of WeGo service.

GUIDELINES

The following guidelines should be used to assist in deciding stop placement:

- At stops adjacent to crosswalks, the boundaries of the stop should be at least 10' away from the crosswalk.
- Bus stops should be located within public right-of-way. (Easements can be considered on a case-by-case basis)
- Bus stops should avoid being placed in front of curb cuts, storm drains and swales.
- Bus stops should be located in places with minimal above grade obstacles (guide wires, power poles, utility boxes, etc.).
- Desired minimum lengths for bus stops based on stop location and bus size are provided below in **Table 3**.

Table 3 - Platform Length

Desired Minimum Platform Length				
Stop Position	40' Bus	60' Bus	2X40' Bus	2X60' Bus
Near-Side	35	55	80	115
Far-Side	45	65	90	130
Mid-Block	35	55	80	115

*Source: 2016 NACTO Transit Street Design Guide

- Operation and service time intervals may require space for more than one bus to load at a stop at a time. **Table 4** provides recommendations from Transit Cooperative Research Program's Report 19 – Guidelines for the Location and Design of Bus Stops (TCRP Report 19) on the number of bus loading positions based on arrival rate and total time spent at a stop.

Table 4 - Loading Positions

Peak Hour Bus Flow	Suggested Number of Loading Positions When Service Time Is:				
	10 Seconds	20 Seconds	30 Seconds	40 Seconds	60 Seconds
15	1	1	1	1	1
30	1	1	1	1	2
45	1	1	2	2	2
60	1	2	2	2	3
75	1	2	2	3	3
90	1	2	2	3	4
105	1	2	3	3	4
120	1	2	3	3	5
150	2	3	3	4	5
180	2	3	4	5	6

BUS STOP PLACEMENT

In general, far-side alignment is preferable. The following table provides guidance for common scenarios and the preferable placement of the stop.

Table 5 - Preferred Placement

Situation	Preferred Placement
Far-side bus accumulation would spill into intersection and additional length is not available	Near-side
Route alignment requires a left turn	Far-side, a minimum of 75 feet after the left turn
Route alignment requires a right turn	Far-side, a minimum of 100 feet after the right turn
High volume of right turns at intersection	Far-side
Complex intersection with multi-phase signals or dual right or left turn lanes	Far-side
When the route alignment requires a left turn and it is unfeasible or undesirable to locate a bus stop on the far side of the intersection after the left turn	Mid-block
When transfer activity between two lines exhibits a strong direction pairing (e.g. heavy volumes from westbound to northbound)	One near-side, one far-side to eliminate street crossings required to transfer
If two or more consecutive stops have signals	Alternate near-side and far-side (starting near-side) to maximize advantage from timed signals

DRIVEWAYS and INTERSECTION SIGHT DISTANCE

WeGo's transit system is focused on areas of activity within a network of intersections that emphasize pedestrian mobility at its core. The system operates within Nashville's existing and growing development space, so overlap with commercial driveways is common. The interaction of buses with intersections and driveways introduces opportunities for conflict, both for buses and passengers.

GUIDING PRINCIPLES

Stops need to make the best use of available space and avoid sight distance issues. Buses stopped at intersections may block visibility for both pedestrians attempting to cross the street and vehicles attempting to enter the roadway. Placement of the stop should balance the need to be near the intersection for passenger access and the need to maintain safe visibility. Placement near driveways should be avoided when possible, but poor access management along corridors may make the occurrence unavoidable. When presented with an instance that involves intersections and driveways, it is preferable to block driveways rather than intersections.

Below is a set of guidelines focusing on safety and visibility at intersections and driveways that should be followed when installing or updating WeGo bus stops and transit centers.

GUIDELINES

As mentioned in earlier guidelines, at least 10' of clear sidewalk space should be provided between the bus and the intersection at stops to allow for pedestrian visibility. This facilitates eye contact between pedestrians attempting to cross the street and vehicle or bus drivers at the intersection.

It is preferable that bus stops are not placed near a driveway; however, if placement near a driveway is unavoidable, the guidelines below should be followed:

- Locate bus stops to allow adequate visibility for vehicles leaving the property and to minimize vehicle/bus conflicts. This is best accomplished by placing bus stops where driveways are behind the stopped bus.
- Attempt to keep at least one exit and entrance open to vehicles accessing the property while a bus is loading or unloading passengers.
- When there are two driveways to a parcel on the same street, the upstream driveway would preferably be blocked in order to force vehicles to turn behind the bus to access the driveway.
- It is preferable to fully block rather than partially block a driveway to prevent vehicles from attempting to circumvent the bus in a situation with reduced sight distance.
- Ensure that passengers have a safe area to wait when loading must occur in or adjacent to a driveway.

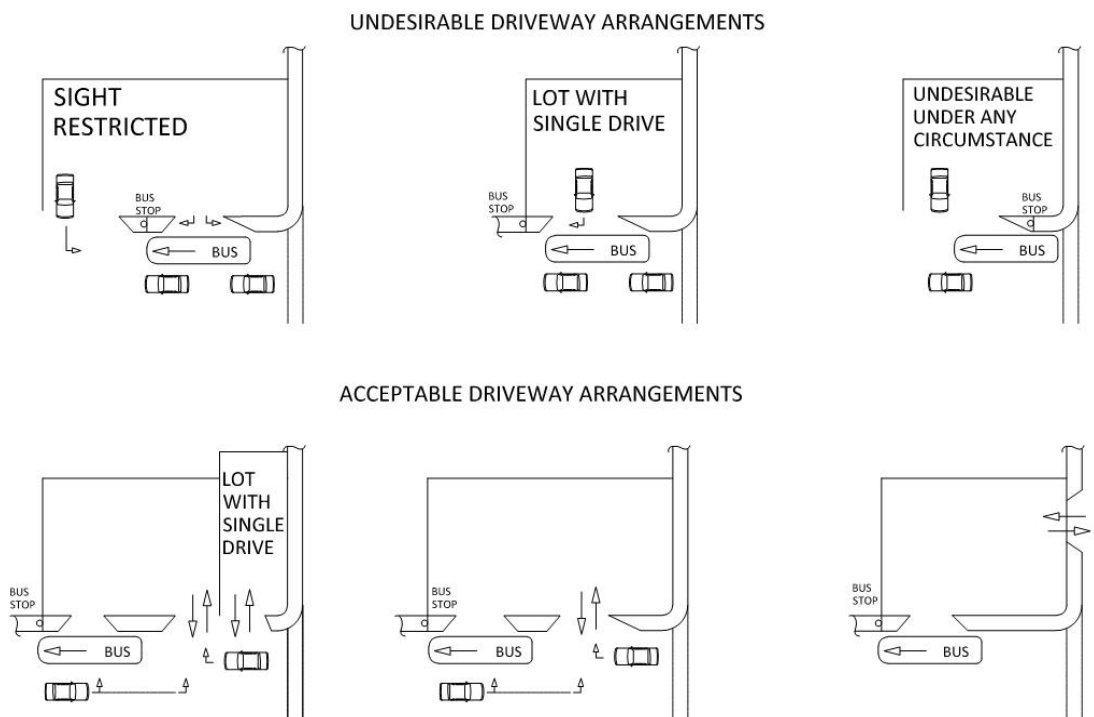

Figure 7 provides examples of undesirable and acceptable driveway arrangements.

Figure 7 - Driveway Arrangements

STOP DESIGN ALTERNATIVES

There are several alternative design layouts that WeGo utilizes to adjust to site-specific conditions for different routes. To improve service efficiency, it is desirable to have the bus stop next to the curb in the travel lane, or alternatively, in cases where layovers are required or on routes with higher volumes of transfer activity, the bus can pull out of the travel lane into a boarding area. The following section provides guidelines for curbside configurations (bus bulbs and boarding islands) and pull out configurations.

GUIDING PRINCIPLES

When implementing any of these stop configurations, the following guiding principles should be considered:

Accessibility

WeGo stop configurations must adhere to the same ADA accessibility requirements as typical stops, including maintaining accessible routes, slopes and clear space when shelters and benches are used. With configurations like the bulb stop or boarding island, the additional curb should help meet ADA requirements. When amenities are added in, designers must be sure to maintain Metro Public Works clear path requirements. Pull-outs, on the other hand, may reduce the available area to meet ADA accessibility and loading zone requirements, which should be taken into consideration during design.

Safety

Most configurations alter the typical pathway of the sidewalk, so care must be taken to ensure that safety is not compromised in their design. Bulbs and boarding islands position passengers in line with parked vehicles and bicycles, so visibility and clarity of routes is important. Pull-outs and bus bays may reduce the available sidewalk width, so the closer interaction between passengers, pedestrians, and vehicles needs to be considered.

Space Utilization

Each configuration requires additional space for passenger and bus zones. Every effort should be made to keep the boundaries of the stop within existing right-of-way to reduce the need for agreements with second party land holders.



STOP DESIGN ALTERNATIVES

CURBSIDE STOP CONFIGURATION

Curbside stops allow the bus to stop in the travel lane. This saves time by removing the need to pull in and out of the travel lane and re-enter traffic. The drawback to this is that the bus can potentially disrupt traffic flow during loading and unloading if there is no additional lane for traffic to pass. The choice of stop location and coordination with signal timing can play an important role in mitigating the disruption to traffic. A layout for a typical curbside stop configuration is provided in **Appendix B**.

Bulb Stop

Bulb stops are a method of implementing a curbside stop when on-street parking is present. Bulb stops extend the curb into the area of the parking lane, bringing the curb adjacent with the travel lane and allowing the bus to stop in the lane. An example of a bus bulb stop is shown in **Figure 8**.

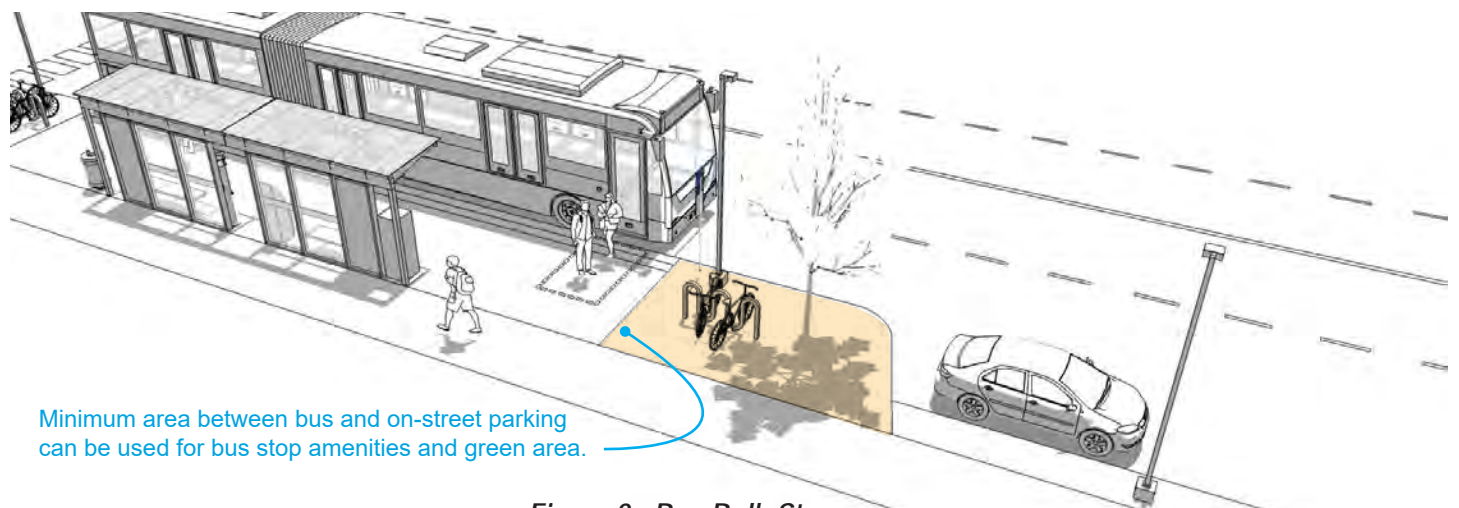

Figure 8 - Bus Bulb Stop

By extending the curb, the bulb can also provide additional space to implement passenger amenities without taking up sidewalk space. A secondary benefit is that the additional curb also extends the pedestrian space into the intersection, which provides better visibility between pedestrians and vehicles and reduces crossing distance.

GUIDELINES

- The length of the bus bulb should accommodate the front and rear entry doors of the bus, which should not be blocked by shelters or other amenities. Refer to bus door dimensions provided in **Appendix A** of this document and platform lengths in **Table 3**. Longer loading zones may be needed if bus queueing is expected due to frequency at the stop.
- NACTO recommends that the bus bulb be roughly the width of the parking lane and have a 45-degree return angle at the parking end.*
- Bollards or other visible delineators may also be needed at the parking end to visibly separate the parking lane from the bus stop.
- Bulb stops may require alterations to existing drainage systems or reconfiguration to improve its effect on drainage at the stop.
- Ensure that any additional amenities that are placed in the area created by the bulb stop are clear of the Metro Public Works required clear path.
- NACTO recommends providing at least 10 feet of clear space between the transit vehicle's stop location and the intersection crosswalk.*

Refer to **Appendix B** for a layout of a typical curbside stop configuration for a rapid service stop.

*Source: 2016 NACTO Transit Street Design Guide

STOP DESIGN ALTERNATIVES

PULL-OUT STOP CONFIGURATION

Pull-out stops are used when considerations of space, traffic flow, and service time restrict the ability to utilize a curbside stop configuration. Pull-outs require more space than a curbside stop because the bus pulls out of and back into the travel lane in order to load and unload passengers, requiring room for the bus to decelerate and accelerate. Solutions include pulling into a designated bay that is cut into the curb or pulling into a designated space within a lane of parked cars.

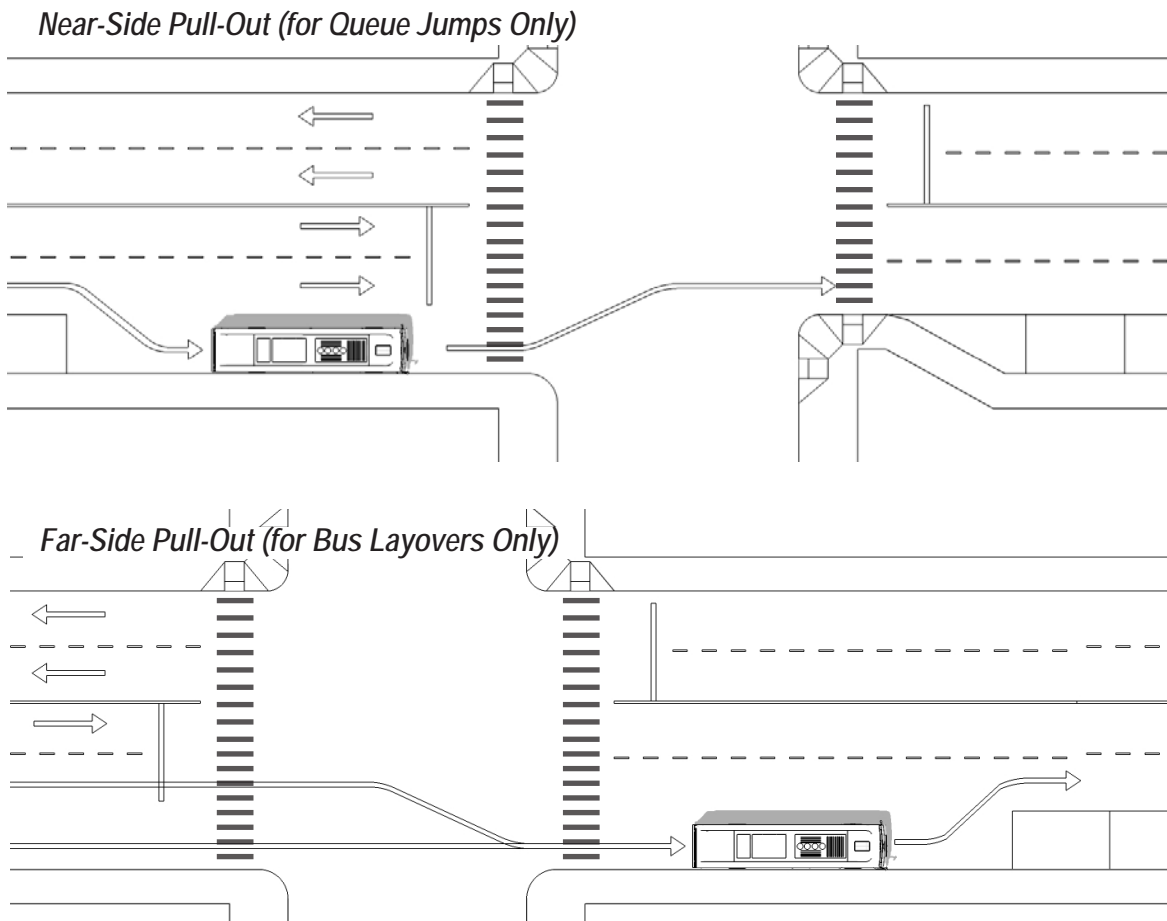

GUIDELINES

While WeGo generally prefers the use of curbside stop configurations, a pull-out configuration should be used at intersections where queue jumps or layovers occur. These locations require space out of the travel lane to mitigate the interaction between buses and traffic, and the intersection is utilized as part of the area needed for the bus to exit or re-enter the travel lane.

Refer to **Appendix B** for layouts of pull-out stop configurations.

STOP DESIGN ALTERNATIVES

COMPARATIVE ASSESSMENT

The table below provides an assessment of the advantages and disadvantages of each of the stop configurations discussed in the previous section.

Table 6 - Comparative Assessment

Stop Type	Advantages	Disadvantages
Curbside	<ul style="list-style-type: none"> Minimal delay for bus Simple, clear location for passengers Easy to relocate 	<ul style="list-style-type: none"> May delay traffic if there are no passing lanes May require the elimination of more parking spaces than a bulb stop
Bulb	<ul style="list-style-type: none"> Minimal delay for bus Improves pedestrian visibility Provides additional surface for amenities 	<ul style="list-style-type: none"> May take away parking spaces May delay traffic if there are no passing lanes
Near-Side Pull-Out (Queue Jumps Only)	<ul style="list-style-type: none"> Minimizes delay to traffic Intersection can be used to re-enter traffic stream if wide enough Can be coordinated with queue jump to provide more opportunities to re-enter traffic Provides opportunity for vehicles to pass bus 	<ul style="list-style-type: none"> Can block pedestrian visibility Vehicles may disregard bus-only markings to use lane for right turns Vehicles may attempt to merge in front of stopped bus to turn right
Far-Side Pull-Out (Bus Layover Only)	<ul style="list-style-type: none"> Minimizes delay to traffic Uses intersection as part of deceleration distance Can be coordinated with signal to provide more opportunities to re-enter traffic Provides opportunity for vehicles to pass bus 	<ul style="list-style-type: none"> Can create alignment issues if the near-side of the intersection is not recessed Re-entry into travel lane can be difficult

BICYCLE LANE CONSIDERATIONS

When bicycle lanes coincide with a bus stop, there are four possible configurations: the bicycle lane continues in front of the stop at street level, the bicycle lane continues in front of the stop at curb level (raised cycle lane) with either a shared or exclusive bike lane, or a boarding island is constructed and the bicycle lane is re-routed behind the stop.

Table 7 summarizes the application of each of these four types of stop based on the available width of right-of-way, which includes the bike lane, grass strip, sidewalk and any available right-of-way behind the sidewalk.

Table 7 - Stop Types Summary

Stop Type	Available Width
Curbside Stop with Cycle Lane	Less than 10'
Raised Cycle Lane (Shared)	Between 10' and 13'
Raised Cycle Lane (Exclusive)	Between 13' and 21'
Boarding Island	Greater than 21'

GUIDLING PRINCIPLES

Each configuration has its trade-offs for bus operations, passengers, and cyclists. The primary goal of the final design should be an effective balance of safety between the three users. When implementing any of these configurations, the following guiding principles should be considered:

Accessibility

These configurations must adhere to the same ADA accessibility requirements as typical stops, including maintaining accessible routes, slopes, and clear space.

Drainage

The introduction of a raised cycle lane or the re-routing of the cycle lane behind the bus stop may alter existing site drainage by introducing obstacles to the flow of water. This will be a site-specific consideration that may require additional surveying and design effort to properly address.

Safety

Each configuration introduces conflict between buses, cyclists and passengers, as there is no solution that can eliminate the interaction of bicycles with buses or passengers. The designer should strive for clear demarcation between buses and cyclists throughout the route, using different stop configurations where applicable. The designer must make the choice that best mitigates the number of ways in which the users conflict. The raised cycle lane and boarding island configurations may alter the pedestrian space, so care must be taken to ensure that routes are clearly designated, and warnings are given when the two cross. Raised cycle lanes eliminate the physical boundary between cyclists and pedestrians, so visibility and clarity of paths is important to improve safety and reduce conflicts.

Space Utilization

Every effort should be made to keep the boundaries of the stop within existing right-of-way to reduce the need for agreements with second party land holders. Boarding islands require the most space but offer the best combination of safety and operational improvements. With respect to raised cycle lanes, it should be noted that the elevation of the bicycle lane may create a shared space between pedestrians and cyclists depending on the available sidewalk width and amenities used.

BICYCLE LANE CONSIDERATIONS

CURBSIDE STOP with CYCLE LANE

The street level application of bicycle lanes is the most common configuration and is shown in Figure 9. This configuration puts the bicyclist and bus in conflict with each other and may lead to the cyclist either diverting into the adjacent travel lane or onto the sidewalk to avoid the bus or having to stop behind a bus while it occupies the bicycle lane. In addition, neither the bus stopping in the travel lane (requiring passengers to step down into the bike lane to access the bus) nor pulling into the bike lane is desirable from an operations and safety perspective.

This type of configuration would be designed as a curbside stop with the bike lane remaining at street level. While not preferred in most cases, this design may be appropriate at stops with lower passenger activity.



Figure 9 - Curbside Stop with Cycle Lane

CURBSIDE STOP with RAISED CYCLE LANE

When a bicycle lane is located in front of a stop, the lane can be elevated to the height of the curb at the stop so that the bicycle lane and sidewalk are at the same level, providing a visual indication of the stop boundary to the cyclist and consistent boarding area elevation for the passenger. The intent of this configuration is to improve the interaction between the bus and cyclist by maximizing available right-of-way when existing site constraints prohibit positioning a bicycle lane behind a bus stop. Bicyclists can use the elevated path when buses are not present but must yield to passengers that are boarding and alighting. An example of this configuration is shown in Figure 10.



Figure 10 - Curbside Raised Cycle Lane

GUIDELINES

A raised cycle lane is the preferred choice to mitigate the conflict between buses and bikes when a boarding island stop is not possible because additional right-of-way is not available. The following guidelines should be used when implementing a raised cycle lane:

- A minimum of 10' in advance of the ramp should be provided for bicycle queuing.
- At far-side stops where there is more than one lane in the direction of traffic, ensure that bicyclists are visible to turning traffic when queued at the ramp.
- Detectable warning strips should be used at all flush transitions between pedestrian and bicycle paths.
- A minimum slope of 1:8 should be used for the bicycle ramp.
- Raised delineators should be placed at the beginning of the ramp to mark the change in elevation.
- The raised cycle lane should extend for the length of the boarding area.

If a raised cycle lane is implemented in a new design or in the reconfiguration of an existing stop, space considerations will be especially important at stops that incorporate passenger amenities, especially shelters. Amenities affect the available clear path on the sidewalk for pedestrians, and minimum ADA and Metro Public Works requirements must be adhered to. This condition can result in two scenarios: one where the two paths are merged into shared space, and one where pedestrians and bicycles have exclusive paths.

BICYCLE LANE CONSIDERATIONS

RAISED CYCLE LANE SHARED SPACE SCENARIO

If a raised cycle lane is implemented at a location where stop amenities are also desired and the available width is between 10' and 13' (as noted in Table 7), the 5-foot minimum clear path requirement and 8-foot long ADA landing pad can be maintained through the additional space added by the raised cycle lane. This space, however, is considered shared space between bicyclists and pedestrians because pedestrians may be required to cross into the bicycle lane to maneuver around stop amenities. This configuration is the least preferred configuration with bike lanes and all efforts to gain additional width behind the sidewalk should be exhausted before this type of design is used. Figure 11 provides an illustration of this scenario using a shelter:

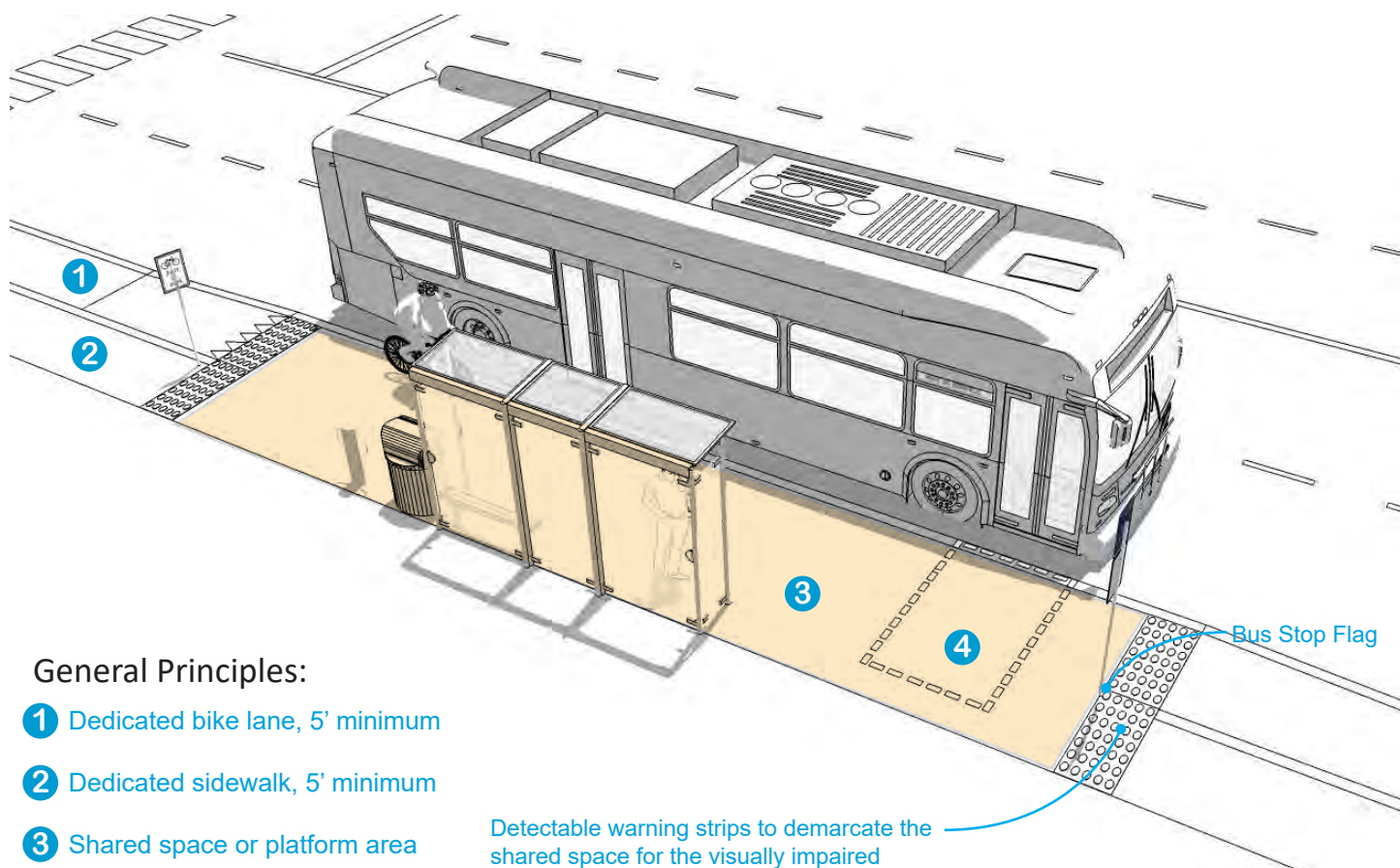

General Principles:

- 1 Dedicated bike lane, 5' minimum
- 2 Dedicated sidewalk, 5' minimum
- 3 Shared space or platform area
- 4 5' x 8' accessible landing pad

Figure 11 - Shared Space Scenario

As Figure 11 shows, the addition of the raised bike lane extends the area in front of the shelter, providing additional space to meet the 5' clear path and 8' boarding area. If this shared stop configuration is implemented, the following additional guidelines should be adhered to in the design to reinforce the nature of the shared space. Refer to **Appendix B** for design standards related to this configuration.

- The bike lane should be colored only on the ramps and in sections leading up to the ramp, indicating that the loading area is not reserved for bicycles.
- Crosswalks should not be used across the pathway of the bicycle, but signing and pavement markings should be used to indicate that bicyclists are to yield to pedestrians within the loading area.
- Detectable warning strips should extend perpendicular to the sidewalk along at both ends of the bicycle ramp (from the top of the bicycle ramp into the sidewalk) to demarcate the shared space for the visually impaired and warn against traveling down the ramp.

BICYCLE LANE CONSIDERATIONS

RAISED CYCLE LANE SEPARATE SPACE SCENARIO

If a raised cycle lane is implemented at a location where at least 8 feet of sidewalk exists, stop amenities can be implemented on the sidewalk without conflicting with minimum clear path requirements. The cycle lane should be clearly delineated from the sidewalk to emphasize the separate modal zones. Figure 12 provides an illustration of this scenario using a shelter:

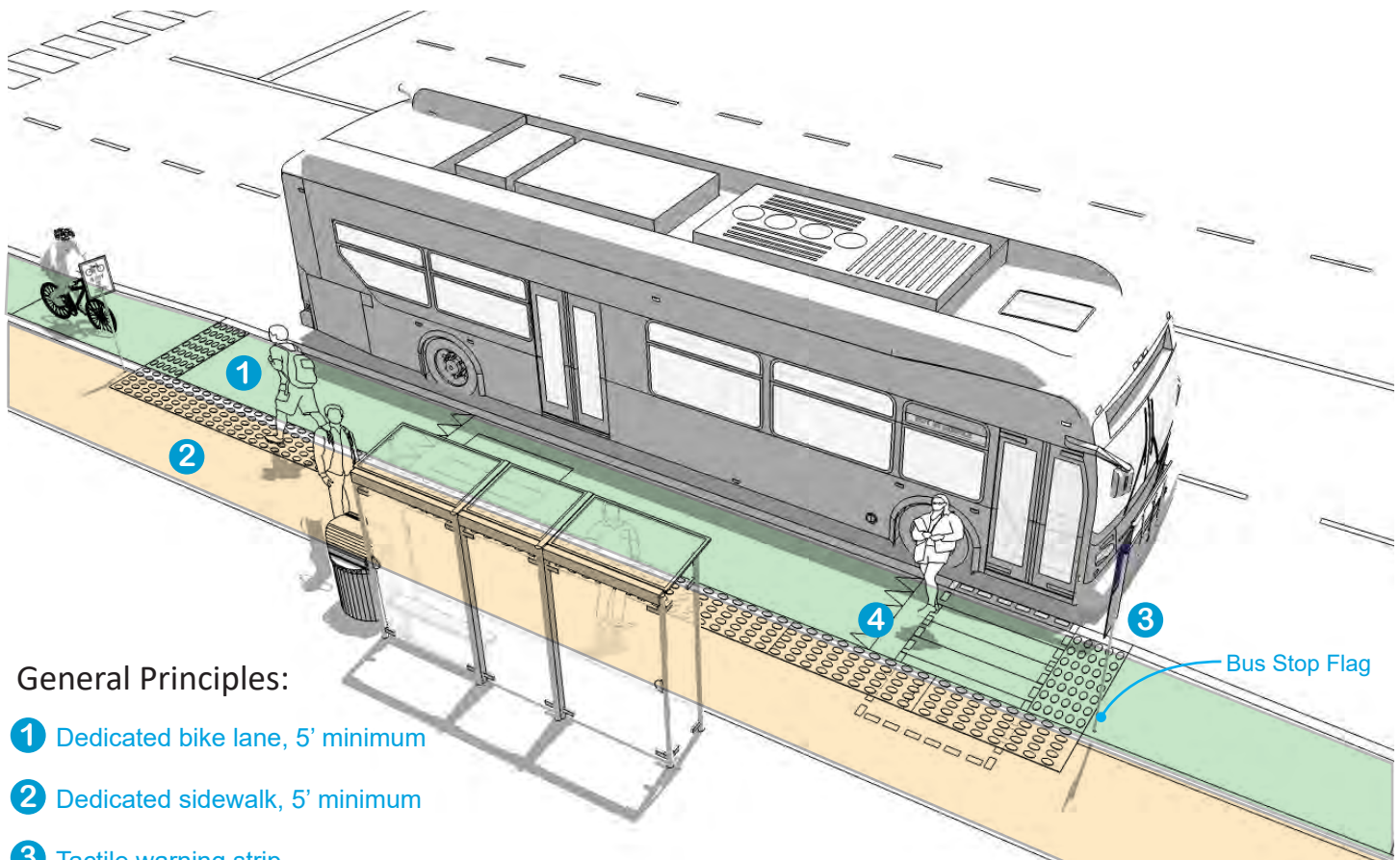

General Principles:

- 1 Dedicated bike lane, 5' minimum
- 2 Dedicated sidewalk, 5' minimum
- 3 Tactile warning strip
- 4 5' x 8' accessible landing pad

Figure 12 - Separate Space Scenario

If this separate stop configuration is implemented, the following guidelines should be adhered to in the design to reinforce the nature of the separate space. Refer to **Appendix B** for design standards related to this configuration.

- Pavement coloring should be utilized for the bicycle lane for the length of the stop, indicating that the lane is not intended to be shared while also providing visual indication of the separate paths and better contrast for pavement markings.
- Crosswalks should be used in conjunction with signing and pavement marking to indicate the loading zones and that bicyclists are to yield to pedestrians within the loading area.
- Detectable warning strips should be applied for the width of the flush transition between the sidewalk and bicycle lane to demarcate the two paths and provide tactile cues to visually disabled passengers.
- Detectable warning strips should be applied in the bicycle lane at the top of the ramp and perpendicular to the sidewalk at the upstream and downstream ends to warn visually impaired passengers against traveling down the ramp.
- Shelters may be reversed and placed at the threshold of the sidewalk and bicycle lane in line with the detectable warning strips to increase the available clear path and further emphasize the separation between the sidewalk and bicycle lane.

BICYCLE LANE CONSIDERATIONS

BOARDING ISLAND STOP

When bike lanes are present, the preferred configuration is to route the bike lane behind the stop, creating a boarding island. This eliminates the conflict between bicycles and passengers during boarding and alighting, which reduces dwell times and minimizes the disruption for bicyclists. An example of a boarding island is shown in Figure 13.

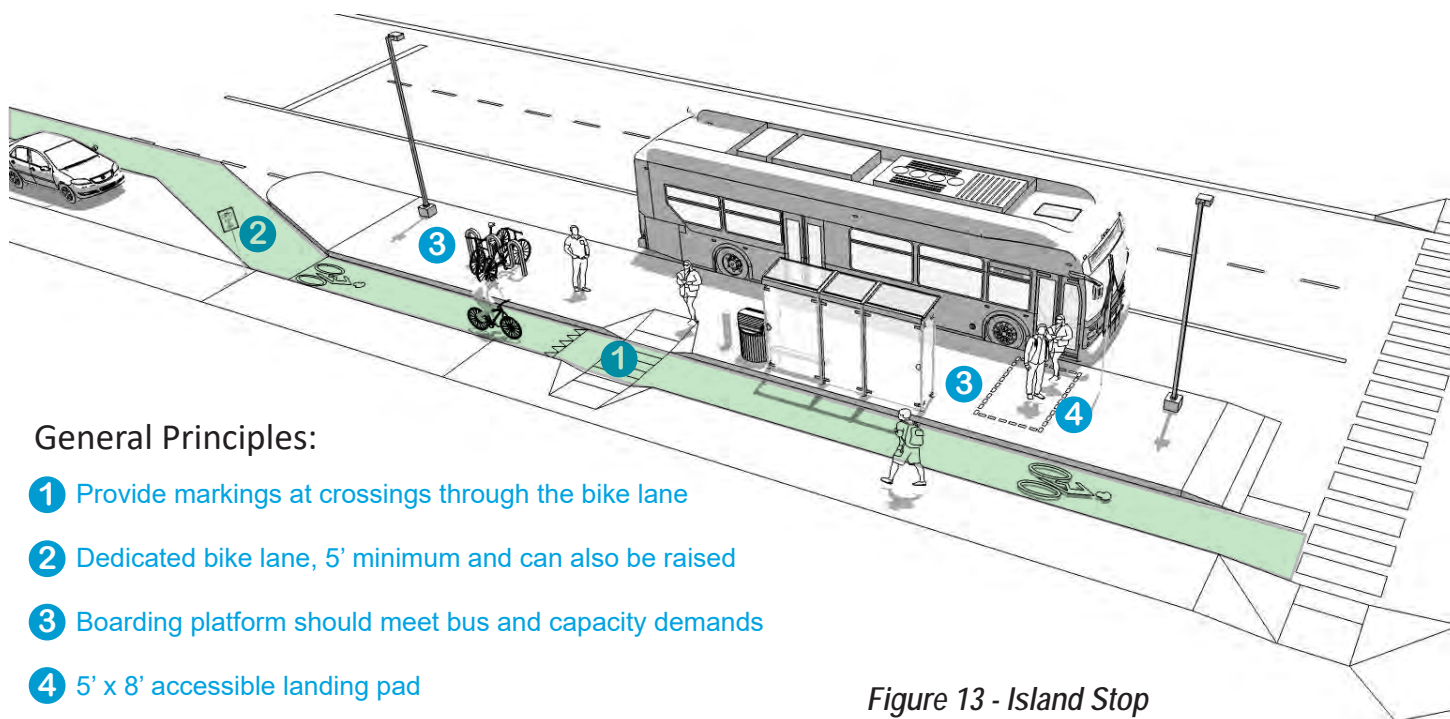

General Principles:

- 1 Provide markings at crossings through the bike lane
- 2 Dedicated bike lane, 5' minimum and can also be raised
- 3 Boarding platform should meet bus and capacity demands
- 4 5' x 8' accessible landing pad

Figure 13 - Island Stop

Figure 13 shows important elements such as a tapered guideway for the bike lane behind the island, striping for the negative space between the sidewalk and bike lane, colored pavement markings for the bike lane and pedestrian crosswalk, and an island cut for the crosswalk. Many of these elements remove the conflict between buses and bikes at the stops by providing each with visual cues to their dedicated path. It also keeps bicyclists from merging in and out of the traffic lane to avoid stopped buses. This does however introduce a conflict between passengers crossing the bicycle lane to get to the boarding island, which can be mitigated by the contrasting bike lane and crosswalk markings.

Like bulb stops, boarding island stops provide a space to deploy ADA boarding ramps without disrupting pedestrian flow on the sidewalk. Boarding islands should also require less complex drainage considerations or modifications than bulb outs.

GUIDELINES

The guidelines for bulb stops presented in the Rapid Service Design Alternatives section also apply to boarding islands. In addition, the guidelines listed below should be followed when implementing boarding islands:

- ADA standards must be adhered to when installing any ramp that allows access to the boarding island. An accessible ramp should be placed at the intersection-end of the island entering the crosswalk to provide direct access to the crosswalk.
- Detectable warning strips must be placed on both sides of every flush crossing over the bicycle lane or entry to a crosswalk.
- Signs and crosswalk markings with yield teeth should be included between the sidewalk and boarding island notifying bicycles to yield to pedestrians.
- Pavement coloring for the bicycle lane should be used to highlight its use.
- Bollards or other visible delineators may also be needed if on-street parking is present to visibly separate the parking lane from the bus stop.
- Alterations or reconfiguration to existing drainage systems may be needed to mitigate the effect on drainage at the stop.
- Railings may be used between the boarding island and bicycle lane to direct passengers to appropriate crossing points.

Refer to **Appendix B** for a layout of a typical boarding island stop configuration for a rapid service stop.

BICYCLE LANE CONSIDERATIONS

COMPARATIVE ASSESSMENT

The table below provides an assessment of the advantages and disadvantages of each of the stop configurations discussed in the previous section.

Table 8 - Comparative Assessment

Stop Type	Advantages	Disadvantages
Curbside	<ul style="list-style-type: none"> Minimal disturbance to operations Modal zones are clearly delineated 	<ul style="list-style-type: none"> Potential conflict between bus and bicycle Potential for bicyclist to merge into traffic to avoid stopped bus Riders would have to step off curb and cross bike lane to board the bus
Raised Cycle Lane (Shared)	<ul style="list-style-type: none"> Minimal disturbance to operations Riders do not need to step off the curb Bus/Bike conflict removed 	<ul style="list-style-type: none"> Potential conflict between bicyclists and pedestrians in shared space No clear delineation between bike and pedestrian areas May impact site drainage
Raised Cycle Lane (Exclusive)	<ul style="list-style-type: none"> Minimal disturbance to operations Riders do not need to step off the curb Bus/Bike conflict removed 	<ul style="list-style-type: none"> Requires more signing and striping to clarify conflicts May impact site drainage
Boarding Island	<ul style="list-style-type: none"> Minimal disturbance to operations Modal zones are clearly delineated Bus/Bike conflict removed Improves pedestrian visibility Provides additional surface for amenities 	<ul style="list-style-type: none"> Requires more right-of-way May impact site drainage Requires more signing and striping to clarify conflicts Introduces conflict area between pedestrians and cyclists May take away parking spaces May delay traffic if there are no passing lanes



Driving
is **booooring.**

Take a ride
and soak
the scene



BENCH FOR MTA CUSTOMERS ONLY — POLICE TAKE NOTICE

3. AMENITIES

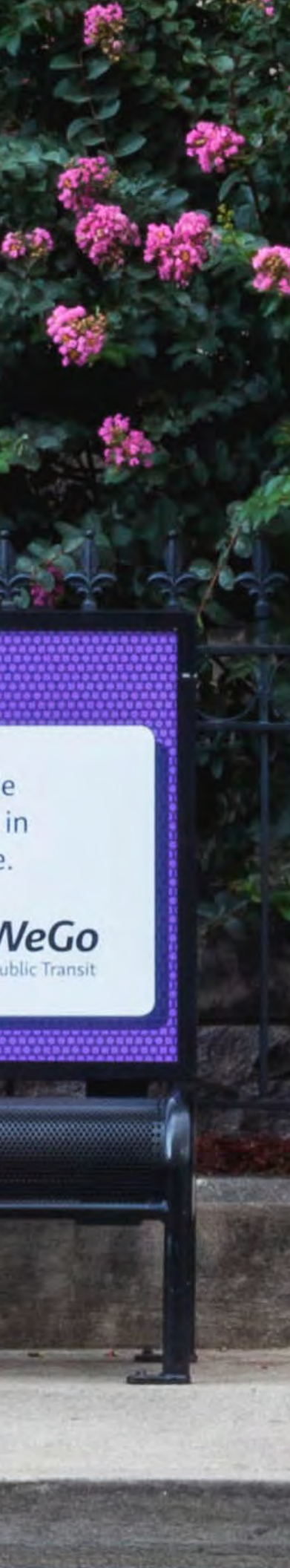

GUIDING PRINCIPLES

INTRODUCTION

An investment in passenger amenities enhances the overall transit experience by making facilities more comfortable, safe, functional, and efficient. Strategically placed amenities have the potential to increase ridership and attract non-riders to the system by making transit more accessible and easier to use. However, due to limited investment resources, WeGo should utilize planning guidelines to maximize the impact and cost-effectiveness of their investment in passenger amenities. Selection of bus stops at which to install amenities takes into account a number of factors, including:

- Total boarding activity
- Proximity to major trip generators
- Passenger transfer activity
- Wait times
- Feasibility of construction (site specific)
- Planned neighborhood improvements
- Transit corridor marketing efforts
- Equity among communities
- Community requests



Bus stop with shelter canopy, seating, and signage

GUIDING PRINCIPLES

Well-designed and cared for facilities reflect positively on the entire transit system. Good design incorporates two primary elements: customer experience and the life-cycle of the stop components. In choosing and applying amenities that improve the customer experience, the following guiding principles should be applied.

Public Safety

Public safety is an important consideration at all levels of the passenger experience because it affects the public perception of the transit service and their choice to use the system. While the accessible nature of public transportation makes it difficult to control all aspects of safety, there are important considerations to be made in the design of transit facilities that can improve it. For example, visibility in and around transit stops improves the customer’s ability to maintain awareness of their surroundings and can discourage inappropriate activity. Visibility can be improved for the customer by utilizing transparent materials for shelters and implementing or improving site lighting. Installing surveillance cameras at select transit centers provides an opportunity to monitor the site and add an extra layer of comfort for users knowing that they are in use. The combination of these two strategies creates a site that discourages inappropriate activity by making it difficult to conceal.

Some stops may not be able to incorporate elements of monitoring due to site specific conditions, and larger sites with more elements and amenities will also provide more opportunities for blocked site lines and covered spaces. In these situations, the design concept should be focused on being as open as possible with special attention applied to evaluating the stop in the context of the surrounding site and maintaining unobstructed site lines to public spaces. Site lighting may also be a higher priority at these stops.



Bus stop with bollard-protected boarding area



Open shelter for ease of seeing approaching bus

GUIDING PRINCIPLES

Accessibility

People of all ages and abilities should be accommodated in the planning and design of bus stops. In addition to state and local requirements, ADA guidelines for accessibility must be adhered to when selecting and designing amenities for a transit facility. These guidelines help ensure that amenities benefit all users and can help ensure they do not conflict with accessibility requirements. Improvements to existing stations should seek to improve accessibility as is feasible.



Bus stop with ramp and warning strip

Rider Comfort

Rider comfort is an important consideration because it can influence the overall perception of the bus transit and affect customer perception of wait and travel times. Comfort can be measured both in the physical comfort in using the transit amenities and vehicles, and in the mental ease in navigating the system itself. Basic amenities such as seating and windscreens are low cost investments with high impact on comfort. Clear, consistent and easily accessible information is a fundamental investment in the system that makes it more accessible for new and regular passengers. Amenities like public art, electric vehicle charging stations and accessible Wi-Fi are more intensive investments, but they can make a larger impact on the impression of the agency's brand as being progressive and invested in the community. Art, architecture and landscaping can have an especially important impact as a strategy of place-making that leaves a lasting impression in the customer's mind.



Bus stop with passenger seating

Signage

Maps, signs, and their graphic elements should be standard across the entirety of the system to improve familiarity and provide consistency across the journey. In addition, the level of signage and detail should be appropriate to the stop so neither are overwhelming nor lacking information. All new station and wayfinding signage should follow the most up to date WeGo signage and mapping available to create graphically consistent elements across the system. In addition, all applicable ADA guidelines for communication elements must be adhered to when selecting and developing these types of amenities. Principles for the types, amount, and location of signage for bus stops are defined in this chapter.



Directional arrows and signage to street

GUIDING PRINCIPLES

Uniform Color Usage

Uniform color usage is an important part of consistent signage as well as in the elements of stop design. Color can be used to define stop elements or provide visual cues, but they must be uniform to be consistently interpreted. Color can also be used in wayfinding to convey information much simpler and faster, much in the same way red, yellow and green are used in traffic signal systems. Principles for the application of the color palette at stops should follow the most up-to-date WeGo branding graphics.



Consistent color use on bus and station signage

Open Design

The addition of amenities to new or existing stops should strive to mitigate clutter in the stop area and adjacent circulation paths. Poorly orchestrated amenities can affect the customer perception of the quality of service and affect site security and monitoring. Placing amenities in such a way that blocks circulation or sightlines makes it more difficult for customers to efficiently navigate the stop and read key information, while also affecting security by reducing visibility. Standardizing the placement of stop elements in an open and efficient manner can improve operational efficiency and customer satisfaction.



Transit center with transparent canopy

DESIGN ELEMENTS

The life-cycle of existing and new materials used to create amenities is an important consideration because it affects how often maintenance and replacement will interrupt operation, how the customer perceives the stop, and will dictate the cost and effort to maintain the stop. A comprehensive evaluation of the life-cycle cost includes:

- Sourcing and availability
- Manufacturing and delivery lead times
- Potential for cost fluctuation
- Ease of installation and access
- Availability of replacement parts
- Required maintenance routine
- Performance life
- Degree of customization of components
- Need for special protective coatings and finishes

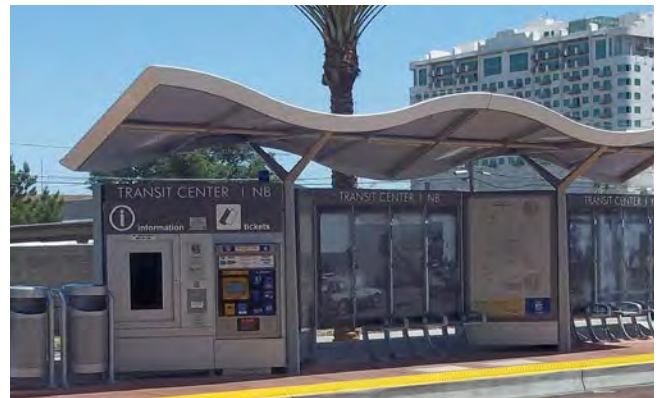

Transit stop with well arranged amenities

Choosing the right material for the stop amenity can reduce its overall cost by reducing the time needed to maintain, repair or replace it. In choosing amenities that meet these life-cycle goals, the following guiding principles should be applied.

GUIDING PRINCIPLES

Durable Materials

Material durability directly affects the transit facility, with strong durability allowing for less service interruption and maintenance interference, which enhances the rider experience. The effects of weather and daily public usage are the two primary factors in measuring durability. Transit facilities receive daily wear and tear from these two sources, requiring more robust materials to ensure length in their serviceable life. Characteristics to consider are resistance to vandalism, susceptibility to moisture, scratch resistance and the durability of moving parts.

Standardized Components

Customized amenities can give unique character to a transit facility and add context sensitivity to the surrounding site, but they also have more specific manufacturing, installation and replacement requirements. In general, amenities should be standardized to reduce cost and time requirements. The standardization of pieces reduces the overall cost and makes their installation and maintenance procedures repetitive and thus easier to learn. Materials can be ordered in bulk and kept in stock, cutting down on lead times, and they are easily interchangeable.

Access & Replacement

Replacement parts should be quick to source, easy to find, or simple to reproduce if they are produced in-house. Easy, secure access to materials or stocked items should be considered early in the planning and design process due to how this affects the speed of repair and replacement. Amenities that require electrical and IT infrastructure need easily identified and well-placed access panels to be incorporated into the design of stop structures, and secure access should be standardized to reduce the opportunities for lost keys, pass codes, etc.

Cleaning

The cleanliness of transit facilities impacts both the customer and the general public's perception of the transit system. Choosing materials that require less cleaning or are less susceptible to showing dirt or fingerprints reduces the amount of time and staff needed to maintain a clean appearance. For example, designing stops that are open with less corners for dirt and debris to accumulate reduces the cleaning effort needed at the stop. Protective coatings, such as anti-fingerprint, scratch-resistant, and anti-graffiti coatings, should be used when possible to reduce maintenance and cleaning needs, while fabrics shall be avoided for any components.

Large transit centers, which are likely to have more passengers waiting or transitioning between modes, should be designed with cleaning equipment in mind. When cleaning is required, surface materials should be easy to wipe down or require uncomplicated equipment and processes.



Standard shelter stop components



Cleaning and maintenance at stop

AMENITIES - APPROACH

Introduction

The WeGo system includes hundreds of various bus stops that can be unique depending on their location, site constraints and surroundings. Many factors must be evaluated at each site when determining the types of amenities to consider: Right of way, adjacent properties, zoning restrictions, ridership, safety and accessibility. Guidelines help to determine the level of investment and the types of amenities for each stop type including sign, bench, shelter, rapid service or transit center.

Through partnerships with the City, County, Developers and the Community, WeGo is investing in the overall system and its patrons. WeGo is committed to improving rider experience and its facilities so that every passenger has a safe, comfortable and efficient experience. Perceived passenger wait time is affected greatly by the amenities that each stop has and by providing shelters, bus arrival times, wayfinding and other stop elements, the passenger will be more informed and comfortable during their trip. This section of the guidelines establishes the various amenities that accompany each transit stop type. **Table 9** provides a list of each system amenity along with the associated bus stop type. The following amenities should be provided where listed with an important understanding that each site may have constraints which restrict the placement of a particular element. Basic ADA-related notes are included with amenity descriptions with additional ADA details for specific amenities located in **Appendix A**.



Transit center illustrating various amenities

AMENITIES - MATRIX

Table 9 - Amenities by Stop Type

Amenity	Local Service			Rapid Stop	Standard Transit Center	Expanded Transit Center
	Sign Stop	Bench Stop	Shelter Stop			
Bus Stop Signs	X	X	X	X	X	X
Benches		X	X	X	X	X
Trash Receptacles		X	X	X	X	X
Bicycle Racks				X	X	X
Shelters			X	X		
Site Lighting				X	X	X
Next Bus Signs				X	X	X
System Maps and Timetables			X	X	X	X
Integrated Advertisement		X	X	X	X	X
Canopies			*	*	X	X
Local Area Maps and Wayfinding					X	X
Ticket Vending Machines					X	X
Bicycle Lockers					X	X
Surveillance Cameras					X	X
Call Boxes and Emergency Buttons					X	X
Climate-Controlled Waiting Area					*	*
Employee Restrooms					X	X
Wi-Fi					*	*
Vendor Space					*	*
Bollards			X	X	X	X
Landscaping					X	X
Public Art and Placemaking			*	*	*	*
Shared Mobility				X	X	X
Car Share Spots					X	
Electric Vehicle Charging						X
Bus Charging Stations					X	X
Park & Ride						X
Van Pool Space						X
Passenger Pick-Up & Drop-Off					X	
Taxi and Ride Sharing Waiting Area					X	
Supplemental Bus Parking					*	*

X = Included at stop, * = Context dependent

AMENITIES - BUS STOP SIGNS

Bus route and passenger information can be displayed in various ways, the most common being flag signs. Each bus stop must be marked with a sign showing WeGo's logo as well as the bus route numbers that serve that stop. Signs indicate to passengers and drivers where buses stop, as well as publicize the availability of the service. Sign visibility, ADA requirements, and vandalism prevention should all be considered prior to installing a bus stop sign.

WeGo Guidelines

Bus stop signs should be located at the downstream end of the bus stop, on the far side of the accessible landing area, as sign location will identify the approximate location of the front door of the bus. Sign color and style should be coordinated with the most current WeGo colors and styles used for bus stop signs. Signs containing information for the route designation, bus number, nearby destinations, and access information must comply with ADA regulations. Examples of ADA requirements related to bus signs include, but are not limited to, character size, spacing, and legibility.

Design Elements

Bus stop signs should indicate the destination or direction that the stop is serving. All bus stop signs should meet reflective standards to provide adequate visibility. Signs will be standardized to allow for easy maintenance and replacement.

Guiding Principles: Public Safety, Accessibility, Consistent and Appropriate Signage, Uniform Color Usage

Included at: All Bus Stops



Single route sign example



Multi-route sign example



Circuit route sign example

AMENITIES - BENCHES

Bus benches are often viewed as an important amenity for passengers who may have difficulty walking and standing, and generally provide comfort and convenience at the stop. Benches are installed at all standard shelters, and priority at sites without shelters should be given to:

- Stops that serve over 25 riders boarding daily
- Stops with existing infrastructure that can accommodate a minimum clearance of 60 inches (5-feet) between the bench and the edge of the sidewalk curb
- Stops with potential passenger demand due to committed changes in land use development (i.e. increased employment and/or residential density)
- Stops in proximity to establishments such as hospitals, assisted living facilities, schools, or other facilities that serve a diverse group of abilities and ages.

In addition, bus stops with long headways and sites where there is evidence of bus patrons sitting on nearby structures are factors that could influence the decision to install a bench. Providing benches can improve the perception of wait time and customer satisfaction.

WeGo Guidelines

Benches outside of shelters should consider locations near natural cover to promote comfort and provide shade and protection from rainfall. To maintain safety in these situations, locations should also be coordinated with existing ambient lighting to increase visibility of the surrounding area for the transit user as well as to provide notice for approaching buses and passing traffic. Benches at WeGo bus stops must comply with ADA standards such as clear space, accessible routes, bench dimensions, and other related requirements. When benches are located outside shelters, backs must be incorporated that meet ADA standards.

Design Elements

Benches used by WeGo should maintain a uniform design to best utilize standard components and replacement parts. When located in shelters, benches should utilize the back of the shelter for support instead of featuring a permanent back. Benches should use durable yet comfortable materials to encourage their use.

Guiding Principles: Public Safety, Accessibility, Rider Comfort, Uniform Color Usage, Open Design

Included at: Bench Stops, Shelter Stops, Rapid Bus Stops, and Transit Centers



WeGo bench with advertisement



WeGo shelter bench

AMENITIES - TRASH RECEPTACLES

Trash receptacles help control litter at bus stops, which improves the appearance and the overall reputation of WeGo. However, it is important to properly maintain the receptacles and a collection schedule to realize its benefit.

Not all bus stops will have trash receptacles. Selected basic bus stops without shelters may have standalone trash receptacles depending on the need and feasibility. Stops that serve over 25 riders boarding daily will have priority in the decision to install receptacles. At this time, WeGo will only utilize trash receptacles; recycling may eventually be incorporated if required in the future.

WeGo Guidelines

Trash receptacles at WeGo bus stops should be placed at the back of the sidewalk adjacent to benches or shelters and secured to the ground to prevent accidental tipping or unauthorized movement. Placement of trash receptacles should consider distance from surrounding buildings and structures to prevent undesirable access by climbing. Additionally, trash receptacles should use trash bags and be emptied according to WeGo maintenance schedules. To ensure safety and sightlines, trash receptacles should maintain an adequate clearance from driveways and nearby land uses. Before installation, ADA regulations such as accessible routes, clear space and any other applicable sections need to be considered.

Design Elements

Trash receptacles should include lockable lids to enhance security and prevent litter from escaping the receptacle. The opening of the lid should be covered in a manner that prevents large or unwanted objects from being placed in the receptacle. Additionally, trash receptacles that include durable materials such as stainless steel, painted galvanized steel, or aluminum, should be prioritized. Receptacles should be sized appropriately based on collection frequency while maintaining reasonable weight for staff to empty.

Guiding Principles: Public Safety, Accessibility, Rider Comfort, Open Design

Included at: Bench Stops, Shelter Stops, Rapid Bus Stops, and Transit Centers

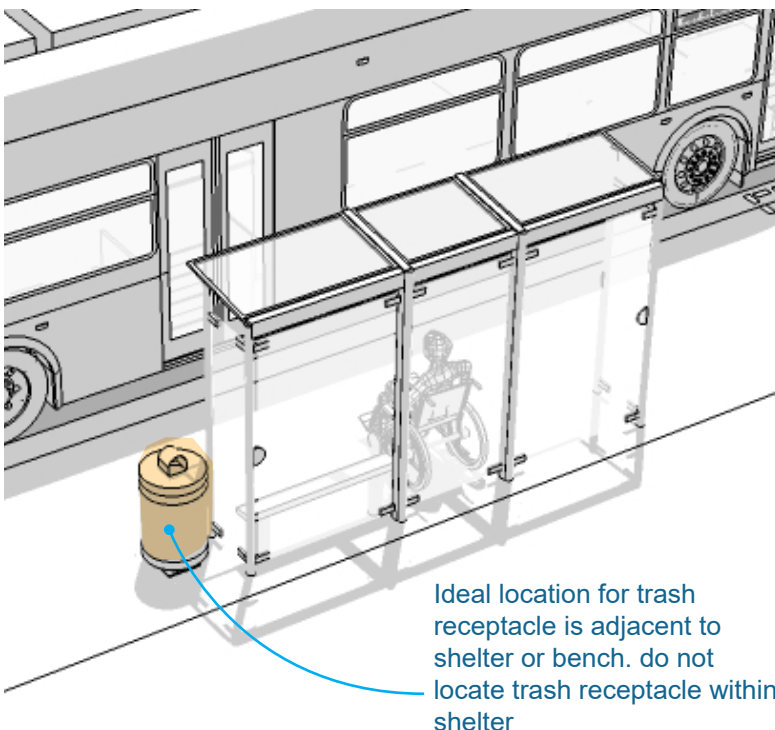

Trash receptacle placement at bus shelter



Current WeGo trash receptacle

AMENITIES - BICYCLE RACKS

Bicycle racks will be implemented at rapid bus stops and neighborhood transit centers, dependent on context, to allow for the temporary storage of bicycles. The inclusion of bicycle racks will encourage transit users to consider bicycles as an alternative mode of transportation that can be used in conjunction with bus transit. The addition of bicycle racks discourages users from locking bicycles to other property located nearby.

WeGo Guidelines

Bicycle racks achieve optimal utilization when located near bicycle-oriented infrastructure such as bicycle paths and lanes. To promote usage, bicycle racks should be prominently displayed near stops and transit centers. When installing bicycle racks, ADA regulations such as accessible routes and clear space should be considered. Placement of racks should allow for connection to the sidewalk and bicycle lane network while also maintaining adequate distance from pedestrian areas to help separate users.

Design Elements

Bicycle racks that support bicycles in two locations such as an “Inverted U” and a “Post and Loop” are recommended due to their size and function. Materials such as painted galvanized steel, stainless steel, or aluminum should be used in the construction of each rack. All racks should be bolted in place to prevent movement. With the growing popularity of dock-less bicycles, adequate rack space should be allocated at transit centers for bikeshare companies to maintain safety, cleanliness, and organization.

Guiding Principles: Accessibility, Rider Comfort, Open Design

Included at: Rapid Bus Stops and Transit Centers, when complemented by appropriate infrastructure



Current WeGo bike rack

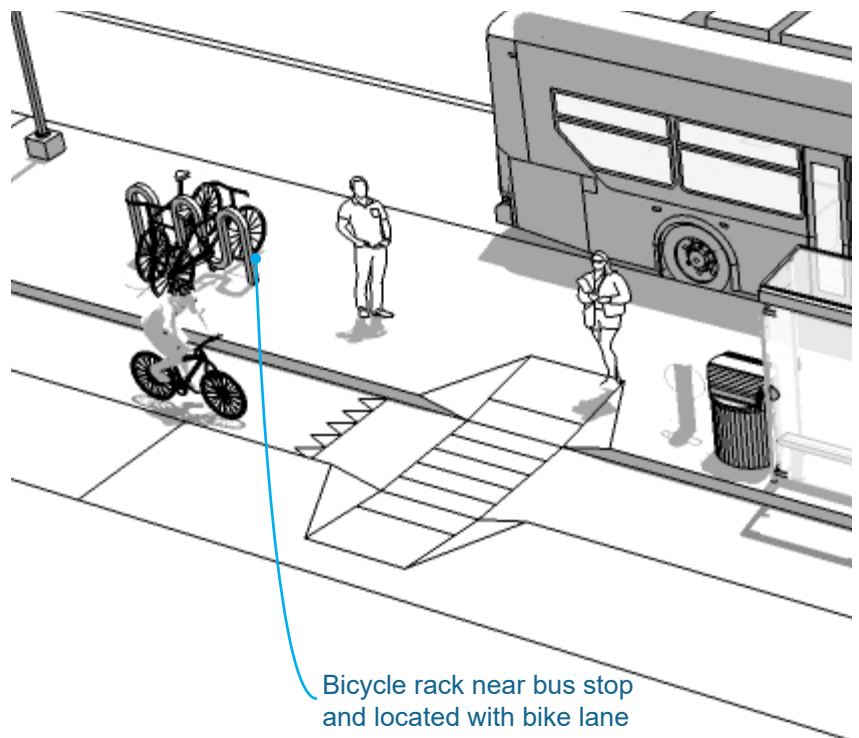

Bicycle rack near bus stop and located with bike lane

Bicycle rack location

AMENITIES - SHELTERS

A bus shelter provides protection from the elements while waiting for a bus. Their placement is limited by available funding, right-of-way constraints, and site-specific conditions. Selecting bus stops at which to install shelters considers a number of factors, including:

- Number of daily boardings and/or transfers

Type	Criteria
Standard Shelter	25 Daily Boardings
Large Shelter	Over 75 Daily Boardings and/or Regularly Have 5 or More Passengers Waiting
Slim Shelter	Applied when Site Conditions Can't Accommodate the Size of a Standard Shelter

- Frequency of service
- Existing land use compatability or expected passenger demand due to committed changes in land use development (i.e. increased employment and/or residential density)
- Availability of space and existing infrastructure to accommodate WeGo's standard bus shelter design, ADA requirements and Nashville Public Works standards
- Proximity to hospitals, assisted living facilities, schools, social service facilities or other major activity centers

System equity, local priorities, and neighborhood requests can also influence the decision to include a shelter at a bus stop. WeGo utilizes four types of standardized shelter to accommodate various site demands and different passenger volumes.

Shelter size, design, and layout will vary, but when feasible, should be large enough to accommodate the number of passengers typically waiting during the busiest times of day.

WeGo Guidelines

Shelters at WeGo stops should incorporate transparent panels to enhance visibility for transit users waiting for their next bus as well as for approaching drivers checking for customers. Shelter panels should use the most up to date WeGo graphics to promote visibility of the shelter for pedestrians and vehicles. Like benches, shelter placement relies heavily on context and should aim to use existing amenities such as site lighting and landscaping to help create a defensible space for transit users while also promoting visibility of the stop. Additionally, adequate clearance between the shelter and the curb should be maintained at a recommended 24 inches to prevent buses from clipping shelters. Shelter design should take into consideration all applicable ADA requirements such as clear floor, accessible routes, landing pads, and other related standards before installation.

Design Elements

Shelters with solar powered lighting are currently used in WeGo's system and should be used for replacements and new installations. Photo cells are included on shelters and will manage when lighting comes on and off based on sunlight. Refer to the most recent vendor specifications used by WeGo for shelter equipment and installation details.

When considering new shelter design, material durability and standardized components across the WeGo system should be prioritized to ease maintenance and upkeep. The use of interchangeable wall panels should also be considered in the event that vandalism becomes an issue at shelter locations. Steel mesh can replace glass panels in the shelter, which are more resistant to vandalism.

Guiding Principles: Public Safety, Accessibility, Rider Comfort, Consistent & Appropriate Signage, and Open Design

Included at: Shelter Stops and Rapid Bus Stops

AMENITIES - SITE LIGHTING

Lighting affects transit patrons' perception of safety and security at stops. Good lighting can enhance a waiting passenger's sense of comfort and security; poor lighting may encourage unintended use of the facility by non-bus patrons, especially in the dark. Lighting at bus stop facilities also allows bus drivers to see waiting passengers and illuminates route and schedule information for patrons.

The costs of installation, maintenance, and availability of power are important concerns when determining how to provide lighting at bus stops. Lighting can be provided by a nearby streetlight, light from adjacent businesses, lighting installed within the shelter, or a stand-alone pole.

WeGo Guidelines

At bus stops, site lighting should be utilized from existing sources such as street lights and other ambient lighting. When determining lighting design at a stop, "over lighting" and "spotlighting" should be taken into consideration as it can negatively impact visibility by hindering users' vision and drawing obvious attention to patrons. To promote sustainable night sky initiatives, light fixtures should be downward facing to help reduce light pollution. Metro Nashville lighting guidelines should also be considered prior to installing new site lighting.

Design Elements

Site lighting should incorporate a standard set of bulbs and fixtures approved by WeGo that are difficult to tamper with, yet easy to maintain for WeGo staff. When installed by WeGo, site lighting should incorporate daytime and nighttime levels to preserve bulbs and energy. If light sources outside WeGo control are used, it is recommended WeGo work in conjunction with the provider to ensure proper replacement and maintenance. When lighting is installed at the bus stop, a consistent standard of lights reinforces the WeGo brand and provides ease of maintenance and replacement for staff.

Guiding Principles: Public Safety, Accessibility, Rider Comfort

Included at: Shelters, Rapid Bus Stops, Transit Centers, and where supported by bicycle activity.



Site lighting from shelter and existing light sources

AMENITIES - NEXT BUS SIGNS

Next bus signs are LED panels or LCD screens that display real-time bus arrival information, system updates, rider alerts and other critical passenger information. Although it does not directly impact the wait time for the passenger, it is intended to improve passenger experience by providing current information on the status of approaching buses that allows passengers to change their wait time expectations, or trip plans if necessary. Next bus signs require mounting surfaces and electrical service for installation.

WeGo Guidelines

LED or LCD signs with proper WeGo branding will be installed at bus bays at transit centers as well as at rapid bus stops. Signs should be positioned in a prominent location at the stop, so riders can easily access ride information. Signs should also maintain proper clearance from traffic and pedestrians, referencing ADA standards related to signage and clear area prior to installation.

Design Elements

Solar options should be considered when installing new next bus signs. To protect signs from vandalism, scratch-resistant materials should be a priority due to the cost of purchasing, installing and maintaining such technology. Next bus signs in use at Central and rapid bus stops should continue to be used as a template unless WeGo changes vendors or designs in the future.

Guiding Principles: Accessibility, Rider Comfort, Consistent and Appropriate Signage, Uniform Color Usage

Included at: Rapid Bus Stops and Transit Centers



Next bus display types

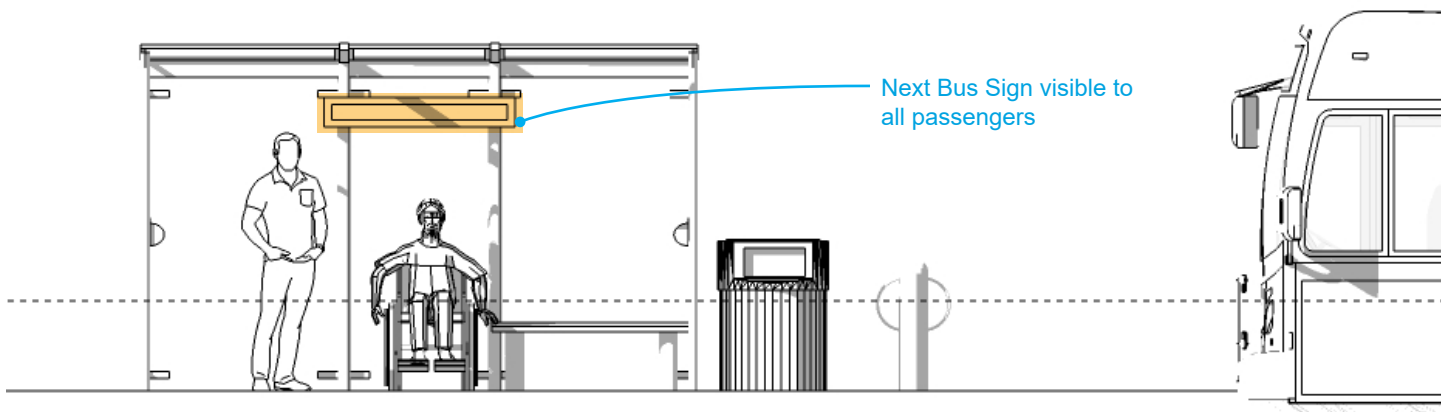

Next bus sign location

AMENITIES - SYSTEM MAPS and TIMETABLES

Route maps and timetable displays are not required at all bus stops, but efficient distribution of route and schedule information to the public is critical to the success of a transit network and adds to the convenience and comfort of the passengers. At busy stops with a large number of passengers or transfers, clear and easily identifiable route information can promptly guide passengers to their destination and improve the efficiency of bus operations.

Route maps may show a single route with fixed schedules or frequencies but can also be scaled up depending on the type of stop, with larger system maps showing pertinent transfer information and timetables. WeGo requires that route maps and timetable displays be provided at the following locations:

- Transfer Points (A fixed location where passengers interchange from one route or vehicle to another)
- Timepoints (A location on a bus route assigned a specific scheduled time that is part of a larger line schedule)
- Stops that serve over 50 riders boarding daily

WeGo Guidelines

At shelter and rapid stops, route maps and timetable displays should be provided within the shelter, when possible. At stops without shelters, route and schedule information should be visible from the accessible landing pad. Signs should be placed perpendicular to the street and mounted below the bus stop sign when possible. Maps and timetables should be displayed for all routes that use the stop.

Design Elements

Maps and timetables will utilize WeGo logos and route colors to designate routes that frequent each stop. Maps will be produced on durable surfaces that are easily cleaned to prevent graffiti, scratches, and other elements from defacing the map.

Guiding Principles: Accessibility, Consistent and Appropriate Signage, Uniform Color Usage

Included at: Shelter Stops, Rapid Bus Stops, and Transit Centers

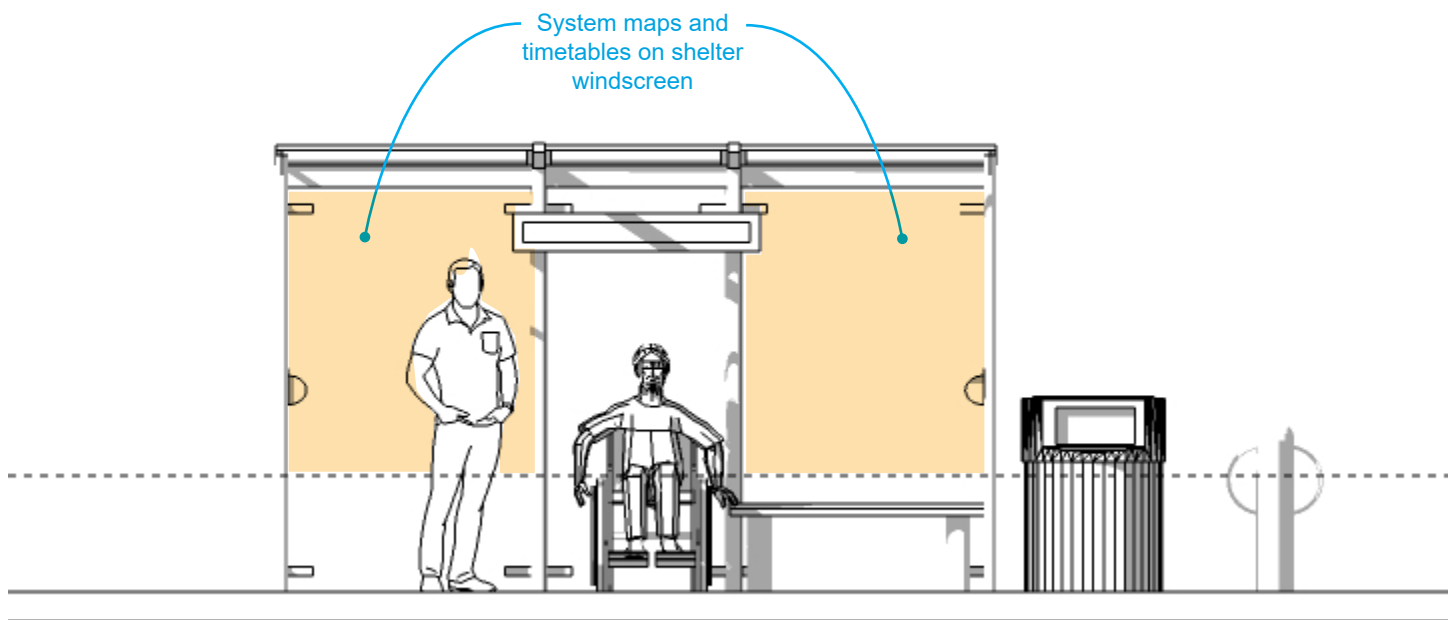

System map and timetable location

AMENITIES - INTEGRATED ADVERTISEMENTS

Advertising is a useful means to help fund the development of transit stops. Advertising on bus benches or shelters, if done properly, can promote the advertiser while also effectively blending in to the surrounding environment. In developing integrated advertising, all state and local requirements must be met prior to implementing new advertisements.

WeGo Guidelines

Advertisements should be supplemental to the primary function of the transit stop, being utilized when appropriate in the context of the stop. Placement of advertisements on bench backs and shelter panels should avoid interference with driver and rider sightlines, and vehicle operations. Additionally, all advertisements must meet WeGo requirements.

Design Elements

Advertisements should be limited to the space provided by WeGo and be constructed in a manner that will prevent vandalism and be easy to clean and maintain.

Guiding Principles: Rider Comfort, Consistent and Appropriate Signage, Uniform Color Usage

Included at: Bench Stops, Shelter Stops, Rapid Bus Stops, and Transit Centers



Bench advertisement



Advertisement area

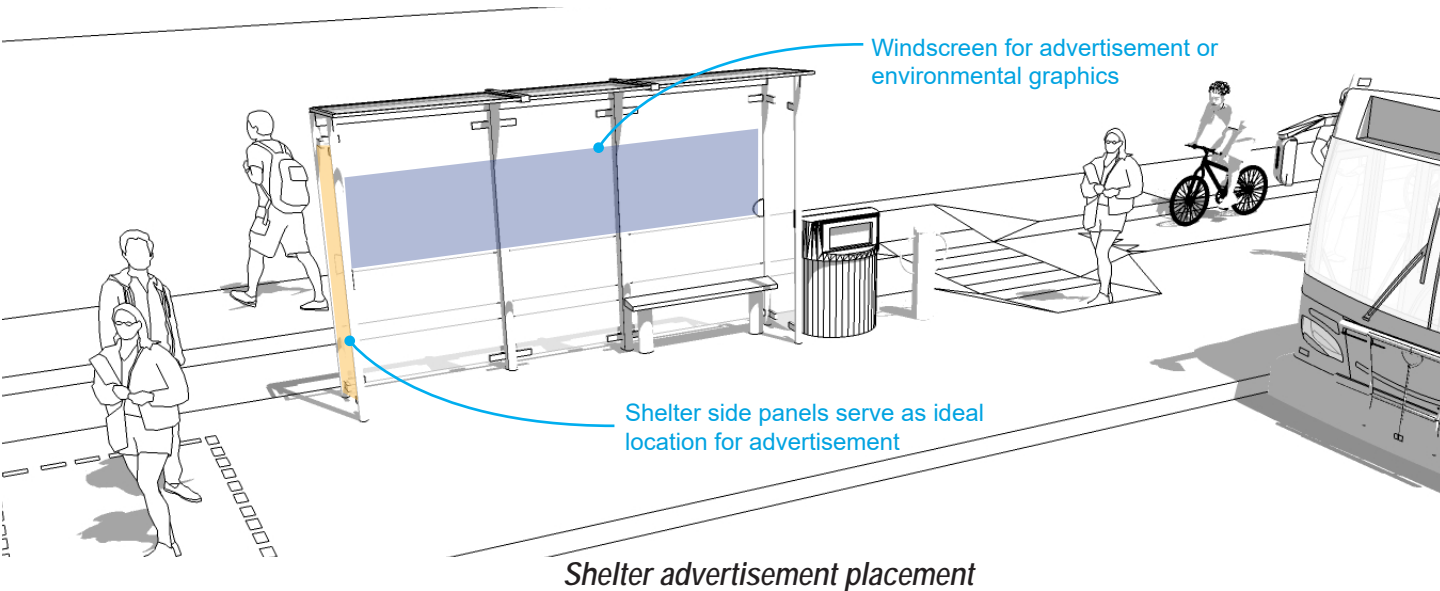

Shelter advertisement placement

AMENITIES - CANOPIES

Canopies provide a covered waiting area that can be utilized for larger stop areas at transit centers or at stops with design constraints. At larger stops, a canopy may be able to cover more passengers than a standard shelter while still providing the same benefits. Canopies do not include walls which allows for easier accessibility and less components to provide and maintain, which can help save costs in development.

WeGo Guidelines

Canopies should extend over the height of the bus, or if shorter, should maintain a 24 inch clearance from the curb. Canopies should be designed to shift potential rainfall and drainage away from the boarding area into a contained system such as landscaping or the storm sewer. Canopies shall comply with ADA requirements such as clear space, accessible routes, and any other related sections

Design Elements

Standard design elements such as durable materials and colors should be used for each canopy and carried over through the different stop typologies, including transit centers. A two-pole support system is recommended to save space and to address unique site constraints such as topography, right-of-way, and accessibility. The size and durability of materials should be appropriate for canopies within the context of the surrounding area.

Guiding Principles: Public Safety, Accessibility, Rider Comfort, Open Design

Included at: Transit Centers, and Shelter Stops and Rapid Bus Stops with design constraints



Canopy shelter utilizing durable materials

AMENITIES - LOCAL AREA MAPS / WAYFINDING

Local area maps provide an opportunity to highlight transit-accessible destinations and emphasize public transit as a link within a community. Wayfinding helps guide passengers to bus stops and makes the coordination of corresponding routes and destinations clearer. When used together, wayfinding signage and local area maps help guide passengers to transit stops or destinations and further emphasizes how transit is interwoven into the area. Implemented correctly, they can improve customer satisfaction by making the accessibility of the network clearer and reducing uncertainty about connectivity.

WeGo Guidelines

When including local area maps and wayfinding tools at stops and transit centers, maps should maintain simplicity, with an appropriate scale and level of detail for the map area. Depending on other amenities included at the stop or transit center, maps should be paired with transit maps and evaluated to avoid redundancy.

Design Elements

Maps and wayfinding should use WeGo and other local and regional authority logos that may help with information. Maps should use consistent orientation (North or the direction the user is facing) at stops to reduce confusion. Wayfinding signage for adjacent bike routes should incorporate design and color schemes from WeGo and other local agencies.

Guiding Principles: Accessibility, Consistent and Appropriate Signage, Consistent Color Usage

Included at: Transit Centers



Local area map



Wayfinding post

AMENITIES - TICKET VENDING MACHINES

Ticket vending machines provide users a simple fare option that also increases boarding speeds. Transit users may purchase single or multi-ride fares with payment card or cash prior to boarding instead of paying while boarding with cash or coins. Allowing users to pre-purchase fares also allows drivers to dedicate increased attention towards maintaining schedules and safety.

WeGo Guidelines

Ticket vending machines should be incorporated at larger transit centers that experience a higher volume of routes and passengers to expedite the boarding process. Recommended locations for ticket vending machines include near street and parking lot pedestrian entrances, or in clear space on bus platforms away from the loading zone to promote visibility and reduce congestion in the loading area. ADA requirements related to ticket vending machines include clear floor area, operable parts, and audio accessibility.

Design Elements

Ticket vending machines should provide clear step-by-step guidance for the purchase of different ride passes. Credit/debit card readers and cash insertion should be included at each machine to provide multiple options for purchase. Machines should use durable materials that reduce the risk of malfunction and vandalism.

Guiding Principles: Accessibility, Consistent and Appropriate Signage, Consistent Color Usage

Included at: Transit Centers



Ticket vending machine at Central

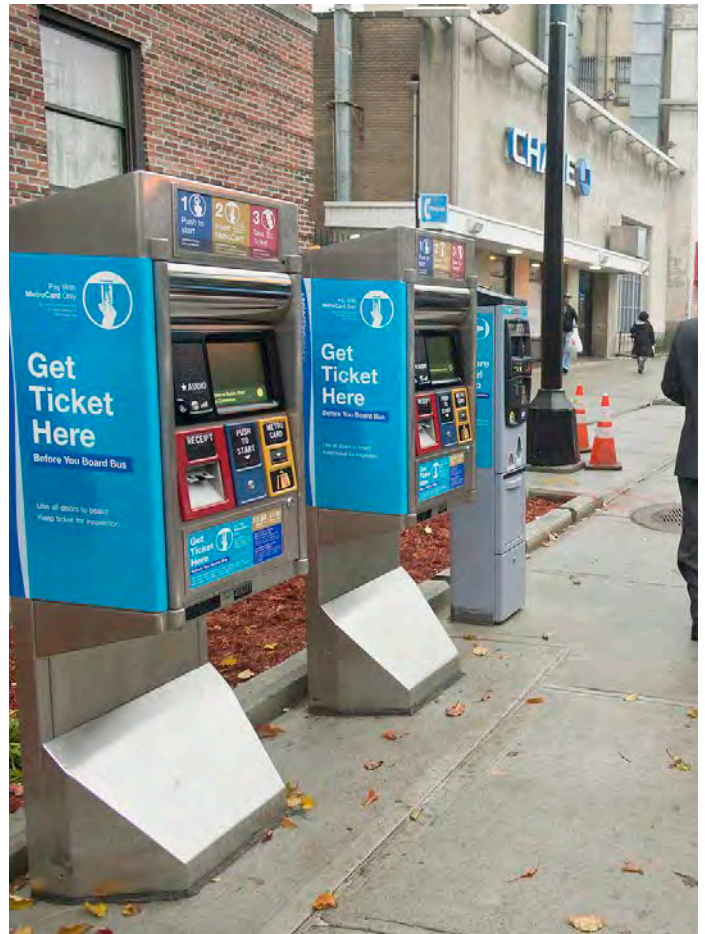

Alternative vending machine style

AMENITIES - BICYCLE LOCKERS

Bicycle lockers allow transit users to safely store their bicycle for the duration of their trip, without exposing the bicycle to the elements. Installing bicycle lockers may encourage users to ride their bike to and from stations knowing that there is an increased level of security for their bicycle.

WeGo Guidelines

When deciding whether to include bicycle lockers at transit centers, the presence of corresponding bicycle facilities should be taken into consideration such as bicycle paths, lanes, and bikeshare stations. Signs identifying location of bicycle locker facilities should be considered to draw attention to their placement. Safe separation from pedestrian, car, and bus traffic is important when placing bicycle lockers. Clear space and accessible routes should be maintained in the surrounding area in accordance with current ADA standards.

Design Elements

Lockers should be placed on a clearly identifiable concrete pad that distinguishes its function at the transit center. Color and design should complement other WeGo amenities such as bicycle racks. WeGo should use a consistent bicycle locker design across the transit system to promote continuity and visibility while also simplifying maintenance and replacement for staff.

Guiding Principles: Public Safety, Accessibility, Rider Comfort, Consistent and Appropriate Signage, Uniform Color Usage, Open Design

Included at: Transit Centers



Bicycle locker design

AMENITIES - SURVEILLANCE CAMERAS

Cameras provide recorded surveillance at transit centers to promote safety and deter vandalism. Surveillance cameras are currently monitored at Central. Cameras at transit centers may require limited space for DVR and on-site equipment while also maintaining viewing and storage capabilities at Central. The addition of cameras not only enhances safety but allows for quick response to any disturbance negatively affecting a transit user's experience and WeGo's operations.

WeGo Guidelines

Cameras will be placed with assistance from a WeGo security vendor, using vendor guidance to determine coverage areas, sightlines, and best practices. Examples of locations that would benefit from surveillance include boarding and alighting areas, ticket vending machines, bicycle racks and lockers, approach paths, and other significant infrastructure based on the context of the transit center. Signage related to surveillance can be placed at key locations throughout the sites based on vendor guidance and WeGo preference.

Design Elements

Cameras will use durable materials and consist of an inconspicuous design to deter interference or damage. It is recommended that surveillance cameras are connected to a separate, reliable energy source to ensure continual operation.

Guiding Principles: Public Safety, Rider Comfort

Included at: Transit Centers

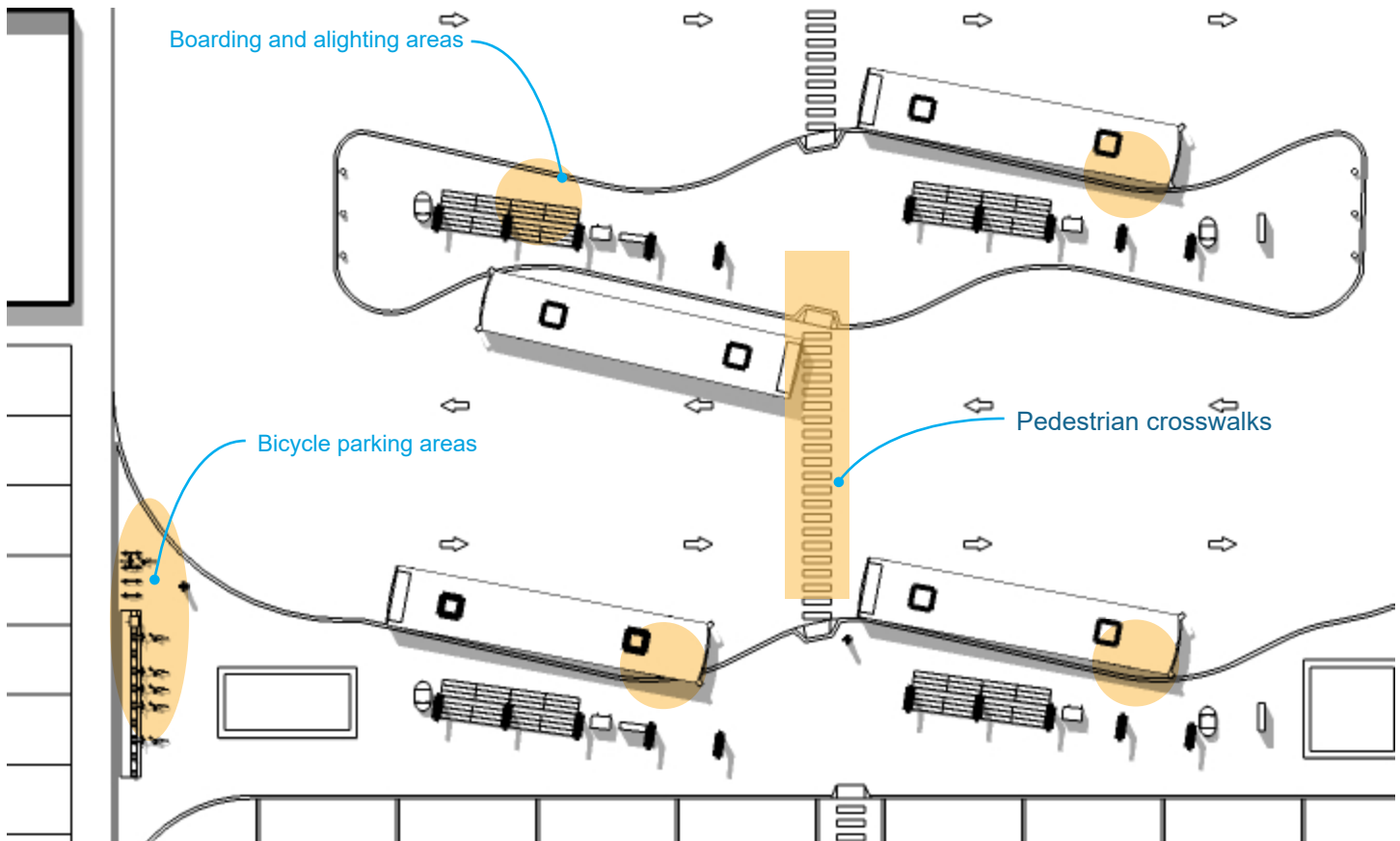

Potential locations for surveillance cameras

AMENITIES - CALL BOX / EMERGENCY BUTTONS

Call boxes and emergency buttons provide a connection to emergency services for transit users without the use of mobile devices. Installations may include a bollard-like structure that includes a way to contact the appropriate emergency services, such as Metro police or other local agencies, and is visible by a colored light.

WeGo Guidelines

Call boxes and emergency buttons should be strategically located within transit centers near high use areas. Areas that isolate passengers should be avoided in the design of transit centers but in cases where it is unavoidable, the addition of a call box or emergency button should be considered. When installing call boxes and emergency buttons, ADA requirements such as clear floor area, operable parts, accessible height and other related standards need to be considered.

Design Elements

A light beacon and raised button should be used to comply with ADA requirements and provide a recognizable location for assistance. It is recommended that WeGo coordinate with other public agencies using emergency call boxes and buttons to use similar designs at new transit centers. Coordinating systems will create a reliable and visible network that will be identifiable by users.

Guiding Principles: Public Safety, Accessibility, Rider Comfort

Included at: Transit Centers



Emergency call button

AMENITIES - CLIMATE-CONTROLLED WAITING

Nashville is subject to a mild climate with the most extreme weather occurring in summer and winter time. Due to the infrequency and unpredictability of severe weather, climate-controlled waiting areas will be considered in transit centers that experience a high frequency of service yet are separated from neighborhood amenities. Adequate site area for construction of such facilities must be present at transit center locations.

WeGo Guidelines

Climate-controlled waiting areas should only be considered in locations with high ridership due to high maintenance levels and cost to build. Location of these facilities near existing utilities and amenities will reduce installation costs and increase usage. To perform as intended, climate-controlled waiting areas need to be fully enclosed except for an ADA accessible entrance to the space. Climate-controlled waiting areas shall comply with all ADA requirements such as clear floor area, accessible routes, and seating.

Design Elements

Waiting areas should follow ADA guidance with respect to window transparency to allow for light and security features to be utilized. Due to their similarity to shelters and canopies, climate-controlled waiting areas should use similar materials, simplifying maintenance for staff. Solar power as an alternative source of energy should be evaluated prior to installation of new facilities.

Guiding Principles: Accessibility, Rider Comfort, Open Design

Included at: Transit Centers

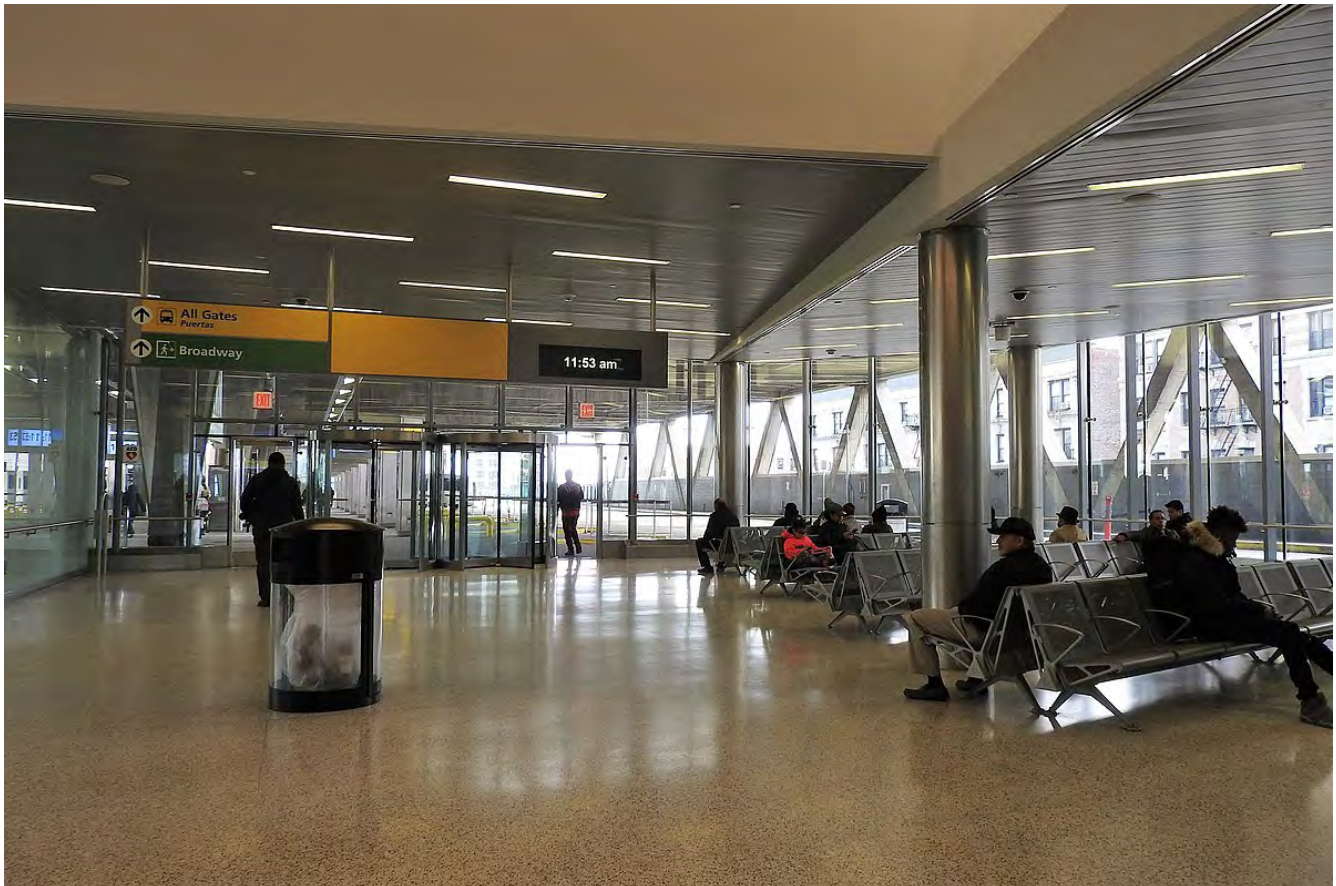

Climate-controlled waiting area at a transit center

AMENITIES - EMPLOYEE RESTROOMS & Wi-Fi

Employee restrooms offer drivers specific facilities for their use at the layover points in their routes. Bus schedules provide break points for employees, and the addition of employee restrooms at transit centers offers a quick and efficient stop for drivers.

WeGo Guidelines

As with climate-controlled waiting areas, the initial cost of construction of restrooms is a major consideration when considering placement. Prior to any decision, nearby alternatives should be identified to ensure that facilities are unnecessarily constructed. Employee restrooms should be placed with other amenities but located in a way that does not draw unnecessary attention to their placement. ADA requirements for restrooms such as signage, grab bars, approaches, and other related standards will apply for employee restrooms.

Design Elements

Employee restrooms should be locked and accessible only by WeGo employees through a provided code, card, or key mechanism, and should use durable materials to increase the life-cycle of the facility.

Guiding Principles: Accessibility, Consistent and Appropriate Signage

Included at: Transit Centers



Potential restroom facility at a transit center

Wi-Fi service allows for riders to stay connected while using WeGo. Users will be able to check real-time information regarding their trip as well as access other useful sites. Providing Wi-Fi at transit centers and rapid bus stops allows for WeGo to maintain the same level of service as other transportation agencies operating in peer cities.

WeGo Guidelines

Wi-Fi will be used in conjunction with installations on WeGo buses. As an amenity for the customer, Wi-Fi provides seamless connectivity across the entire WeGo system. For WeGo, Wi-Fi at transit centers helps the conveyance of information to resources like the Music City Transit Tracker which is currently used on buses to provide real-time arrival status. Signage informing customers of Wi-Fi service and directions to connect should be considered where necessary.

Design Elements

Wi-Fi hotspots at stops and transit centers should be inconspicuous and involve protective measures to ensure the Wi-Fi hotspots operate continually without interruption from various disturbances. Partnerships with private providers and other public wi-fi sources should be considered to promote a regional network and knowledge that the service exists. Current Wi-Fi service is provided through Metro Nashville with installation and energy supply provided by WeGo.

Guiding Principles: Accessibility, Rider Comfort, Consistent and Appropriate Signage

Included at: Transit Centers

AMENITIES - VENDOR SPACE

Vendor space will be considered at transit centers depending on available space and demand. Vendors, operating under the appropriate guidelines, can add unique services that enhance a rider's experience and can lead to an alternative revenue source through vendor fees.

WeGo Guidelines

All Metro Nashville vendor requirements and permits must be met and attained prior to allowing service at transit centers. The availability of vendor space will be dependent on WeGo property ownership as well as site context. Vendors and locations should be chosen with the intention of supplementing the local community and existing businesses, not to compete or replace existing businesses. Vendor space shall comply with all ADA requirements such as accessible routes and approaches.

Design Elements

Vendors, if included, should be provided a clearly defined separate space for operation with necessary utility hook-ups and area for vendor-provided shelter. Guidelines for vendor setup should consider size, design, and vendor product and be consistent throughout the WeGo system.

Guiding Principles: Rider Comfort, Consistent and Appropriate Signage, Open Design

Included at: Transit Centers



Small vendor kiosk in public space

AMENITIES - BOLLARDS

Bollards provide an extra form of security from vehicle traffic while waiting at stops and serve to demarcate the separation of space for pedestrians and vehicles. Separately, bollards can provide an object for support while waiting for a bus to arrive or serve as an alternative light source.

WeGo Guidelines

For safety, bollards should maintain a safe distance from the curb, similar to shelters and canopies to prevent interference with vehicle traffic. ADA requirements such as accessible routes and clear space will apply to bollards installed at WeGo facilities.

Design Elements

In areas that may need additional site lighting, bollards with solar capabilities should be considered. WeGo will use Metro Nashville bollard styles that do not require structural reinforcement. The color and shape of bollards installed at WeGo facilities should complement existing and future amenities such as shelters, trash receptacles, and other amenities.

Guiding Principles: Public Safety, Accessibility, Rider Comfort, Uniform Color Usage, Open Design

Included at: Shelter Stops, Rapid Bus Stops, and Transit Centers



Well-protected boarding area with bollards

AMENITIES - LANDSCAPING

Landscaping at transit facilities should be well defined while also allowing for clear views for riders and bus drivers. Landscaping provides benefits such as an increased sense of safety with defined space, as well as increased comfort with shade and noise buffering.

WeGo Guidelines

Vegetation and ground cover that limit the amount of necessary maintenance should be prioritized at all sites that incorporate landscaping. Plants and material that provide dense covering should be avoided to promote safety and visibility while trees that provide shade but don't interfere with site lighting should be encouraged. Only larger transit centers within the WeGo system should incorporate designed landscaping, with selection of materials based on site area and context. Landscaping should adhere to ADA regulations related to accessible routes as well as any other applicable sections.

Design Elements

Any vegetation installed at WeGo stops must be in compliance with Metro Nashville Development and Storm Water criteria. Vegetation that obstructs views and installed lighting should be avoided to increase safety at the transit station. Landscaping needs to be easily accessible by maintenance staff for litter and brush removal. Watering needs should be determined prior to installation and based on the available infrastructure. This may include in-ground irrigation, a water spigot for hose connection, or by a vehicle with a water tank. A list of approved vegetation and ground cover should be maintained by WeGo to create a cohesive appearance at transit centers.

Guiding Principles: Public Safety, Rider Comfort, Open Design

Included at: Transit Centers



Low maintenance and drought tolerant plantings

AMENITIES - PUBLIC ART AND PLACEMAKING

Transit centers will be the focal point of permanent public art installations that promote placemaking. Public art helps build civic pride and adds a unique element to each transit center.

WeGo Guidelines

WeGo will follow agency procurement standards, with a priority given to local artists for new installations. Art should refrain from offensive and sensitive subject matter and be focused on building community. Public art should adhere to ADA regulations related to accessible routes as well as any other applicable sections.

Design Elements

WeGo will review proposals to ensure that installations can be properly maintained and fit the context of the site. Because the intent of public art is to provide a unique aspect to each site, cohesion and standardized components are not a priority. Instead, maintenance and durable materials should take precedent when analyzing design of public art from WeGo's perspective.

Guiding Principles: Public Safety, Rider Comfort, Open Design

Included at: Selected Stops



Creative bike rack



Public art serving as a canopy



Mural in a transit center

AMENITIES - SHARED MOBILITY

Transportation options throughout Nashville will continue to change in the future and WeGo's system and infrastructure need to be prepared to adapt to and accommodate the different modes available to potential users. Transit centers should allow for compatible space for storage of alternate modes such as dockless bikes and scooters. Some transit centers may incorporate physical infrastructure such as sharing stations that may be located at transit centers to provide additional connection options for WeGo users.

WeGo Guidelines

Shared mobility should be incorporated at rapid bus stops and smaller transit centers. Space for shared mobility should be co-located with other infrastructure such as bicycle racks, lockers, and lanes. Any installations should adhere to ADA regulations such as accessible routes and any other applicable sections.

Design Elements

Durable and visible materials should be utilized in storage spaces for the multiple modes that can be used at different stops and stations to ensure the user is aware and able to properly utilize the space.

Guiding Principles: Accessibility, Consistent and Appropriate Signage, Uniform Color Usage, Open Design

Included at: Rapid Bus Stops and Transit Centers



Bikeshare station near a bus stop

AMENITIES - CAR SHARE SPOTS

Car sharing has gained popularity and its impacts should be considered when designing transit centers. An allotted number of spaces dedicated to carsharing companies should be provided at each transit center with parking. Car sharing is a low-maintenance element that can provide significant value to transit users, consisting of only parking spaces and signage to complete installation.

WeGo Guidelines

Car sharing should be incorporated at smaller transit centers that focus on passenger pick-up and drop-off and feature space for transportation network companies and taxis. Coordinating car share availability with smaller transit centers will provide an additional link to users who do not utilize personal vehicle travel. Signage at transit centers should acknowledge the presence of car share and provide directions where appropriate. In parking lots, car share spots should be given priority and clearly marked with signage and paint to indicate use for car sharing companies. An appropriate number of spaces should be allocated based on estimated demand at each transit center.

Design Elements

WeGo will determine signage and paint when car share spots are proposed, using templates and color schemes consistent throughout the system.

Guiding Principles: Accessibility, Consistent and Appropriate Signage, Uniform Color Usage

Included at: Transit Centers

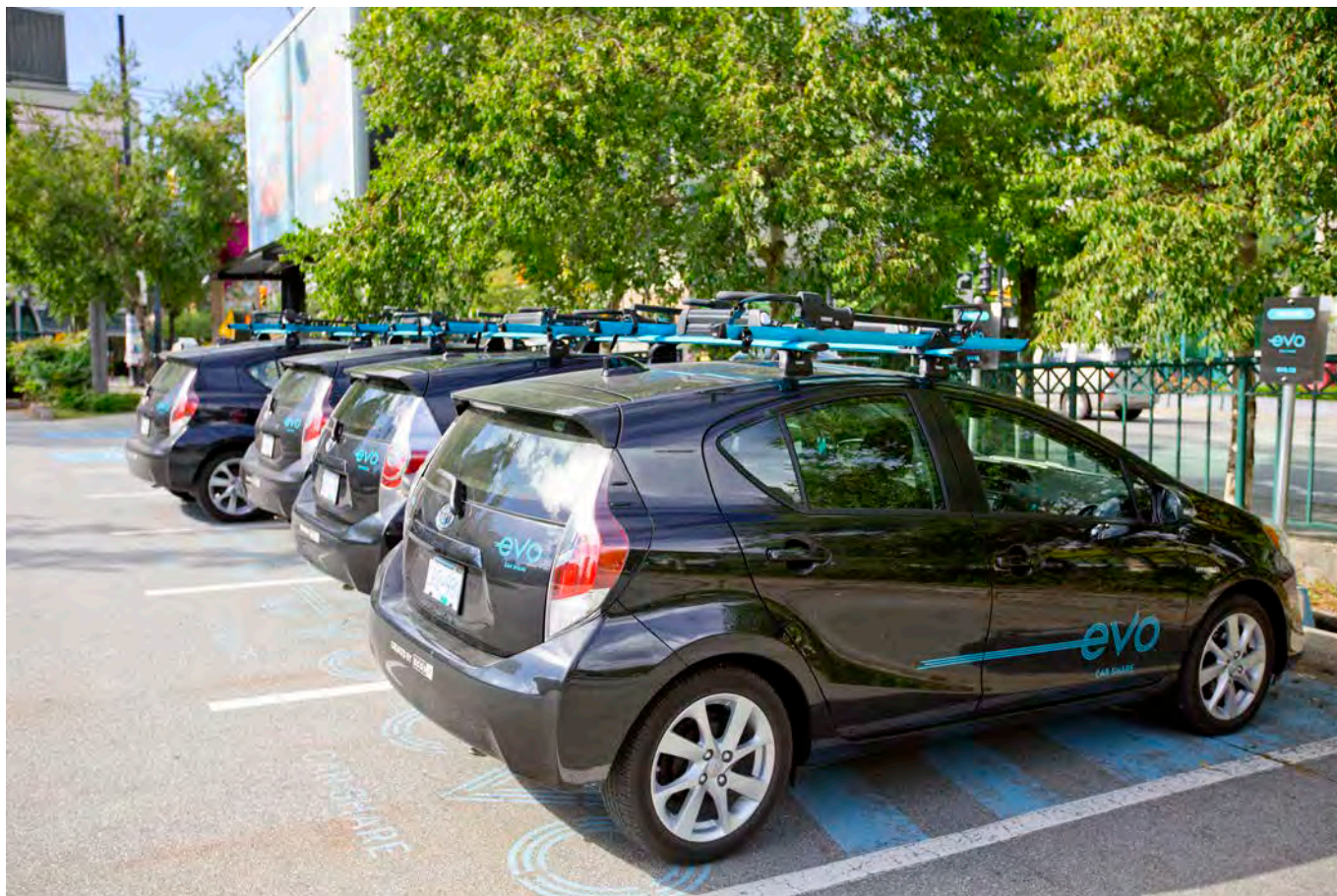

Designated car share parking space

AMENITIES - ELECTRIC VEHICLE CHARGING

As electric vehicles become more prominent, transit centers with park & ride facilities should accommodate such vehicles with charging stations. Electric vehicles use a sustainable source of energy and their users should be incentivized to also consider alternate modes of transit that promote sustainability.

WeGo Guidelines

Similar to car sharing spots, electric vehicle charging locations should be included on transit center signage with directions to spots where appropriate.

Design Elements

Cohesive branding for signage and paint will be used by WeGo when including electric vehicle charging stations at transit centers.

Guiding Principles: Accessibility, Consistent and Appropriate Signage, Uniform Color Usage

Included at: Transit Centers

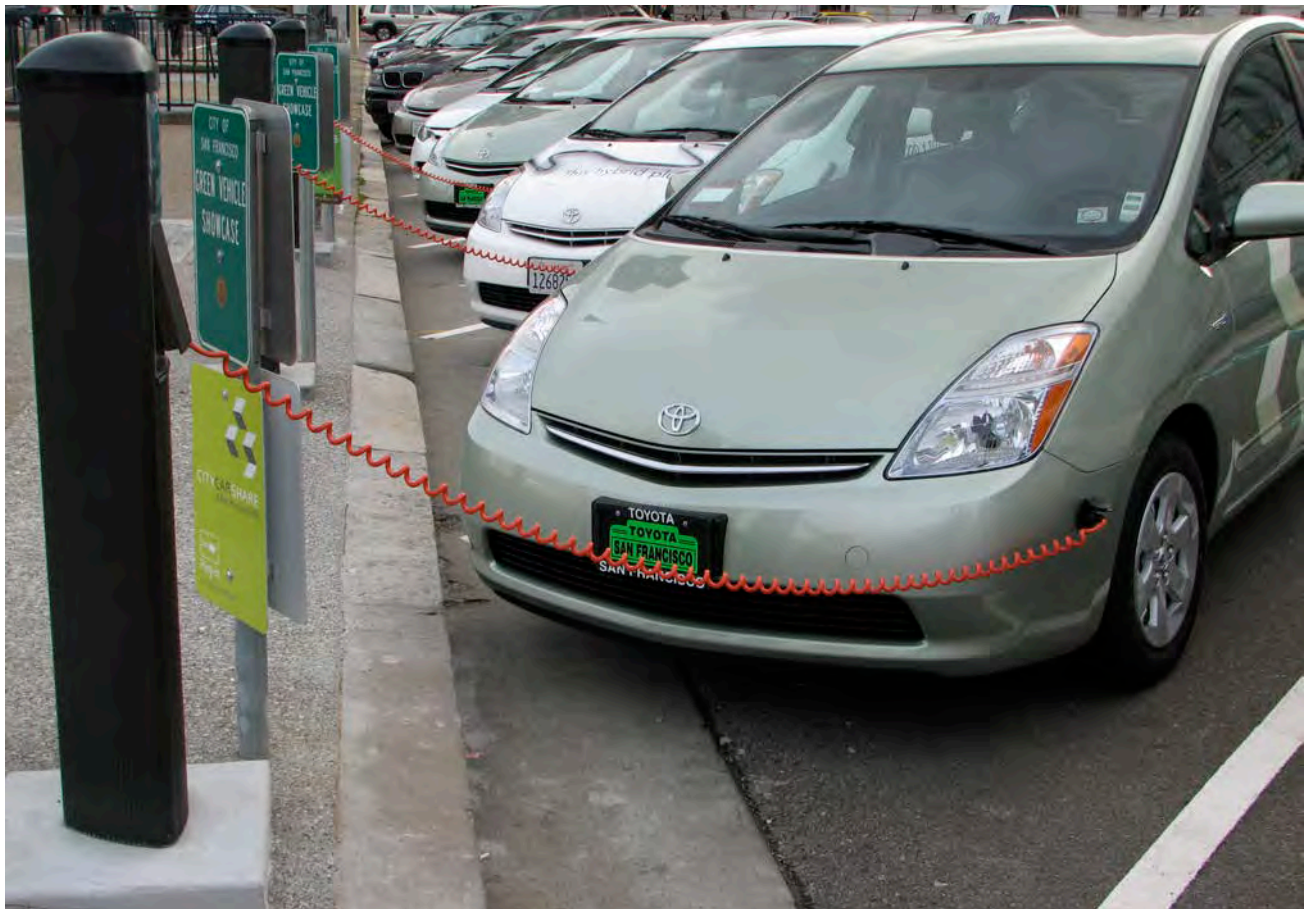

Car chargers at nearby parking spaces

AMENITIES - BUS CHARGING STATIONS

WeGo maintains a fleet of electric buses as a sustainable alternative to typical diesel-fueled busses. To help keep these assets in use, transit centers should incorporate bus charging stations to provide a space for buses to recharge while waiting to embark on their next route. Providing these spaces eliminates transit times to bus maintenance facilities, saves vehicle mileage, and increases the sustainable contributions to the community from WeGo.

WeGo Guidelines

Stations should be incorporated at transit centers on routes that typically use electric buses. Transit centers and layover stops will be logical locations for bus charging due to their extended wait times. Signage associated with the hazards and equipment being used should be posted on or near stations to prevent injury and vandalism.

Design Elements

Bus charging stations should incorporate WeGo color schemes and be constructed with durable materials. Selecting unobtrusive charging stations provides more flexibility in deciding which transit centers will incorporate bus charging.

Guiding Principles: Consistent and Appropriate Signage, Uniform Color Usage

Included at: Transit Centers



Overhead bus charging stations

AMENITIES - PARK & RIDE

Park & ride facilities provide a parking area at major stops to collect riders at a central location. Riders that use park & ride facilities benefit from driving their personal vehicle for a portion of their trip and using public transit to complete the journey. Park & ride facilities draw users from a wide catchment area that may be less dense and allowing drivers to collect at the lot substitutes the need for connector or circulator service in the surrounding area.

WeGo Guidelines

Larger transit centers and stops near the outbound terminus of routes should be prioritized for park & ride facilities due to their location in lower density areas. Ridership will need to be analyzed prior to developing park & ride facilities, looking at factors such as origin and destination, to best determine where they should be placed within WeGo's system. Park & ride facilities shall comply with ADA regulations such as accessible routes, number of handicap accessible parking spots for cars and vans, and any other applicable sections.

Design Elements

Park & ride facilities should incorporate safe pedestrian access from the parking area to the bus loading zone at the transit center. This provides a clear path for pedestrians and separates different modes to improve safety.

Guiding Principles: Public Safety, Accessibility, Consistent and Appropriate Signage, Open Design

Included at: Transit Centers

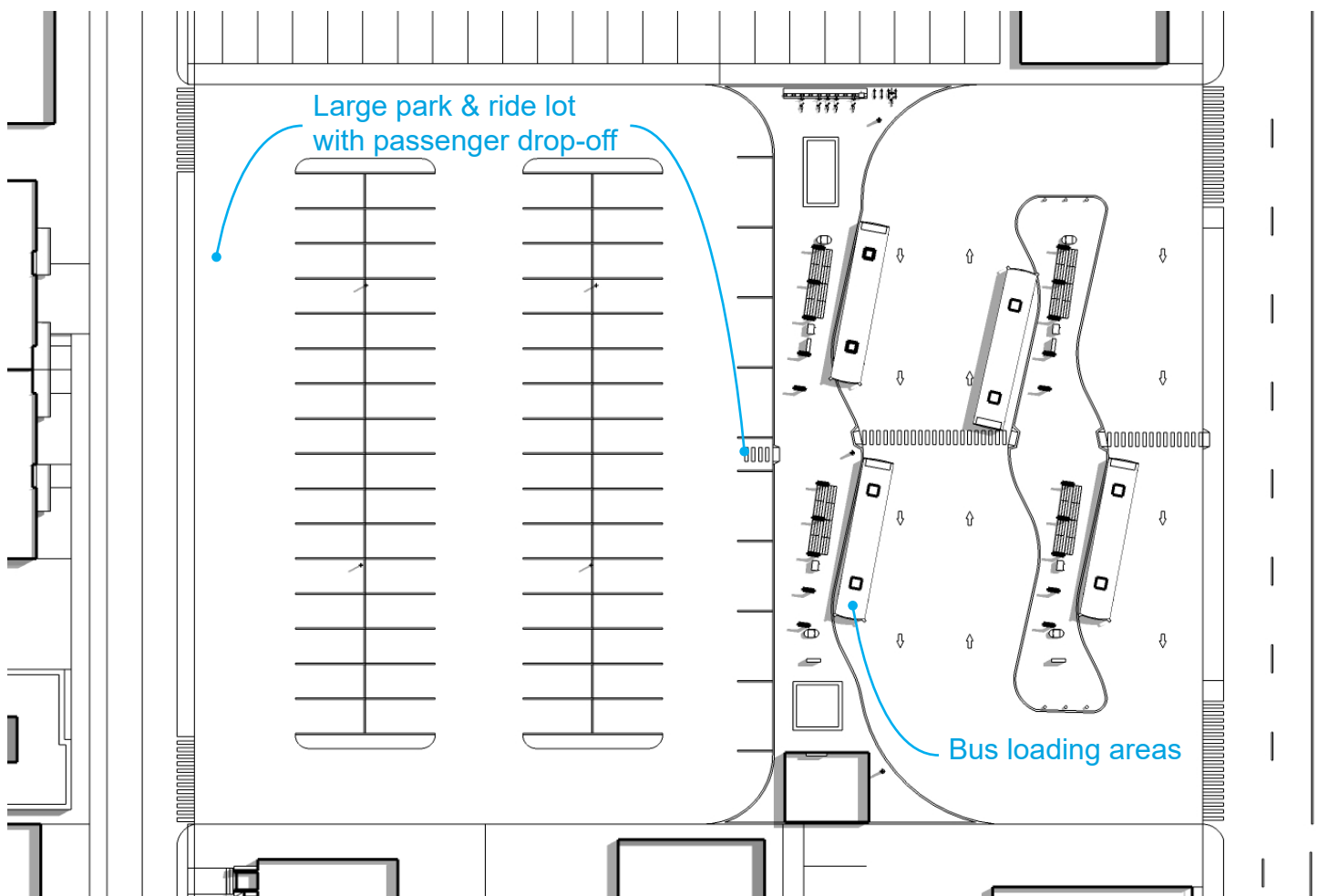

Park & ride lot adjacent to transit center

AMENITIES - VAN POOL SPACE

Van pooling consists of groups with long commutes meeting in a central location to travel together in a van to the same general vicinity. Participants would meet at larger transit centers that include park & ride facilities and ride together to their destination. Incorporating parking spaces for vanpool participants encourages users to ride together and keep vehicles off the road. WeGo promotes van pooling service, with transit centers providing ideal locations to collect users.

WeGo Guidelines

Signage at park & ride facilities should demarcate an allotment of van pool parking spaces. Accessible spaces should be incorporated as part of the larger development of park & ride facilities at transit centers. ADA regulations incorporated at park & ride facilities such as accessible routes and handicap accessible parking spots for cars and vans will be available for van pool users.

Design Elements

Cohesive branding for signage and paint will be used by WeGo when including van pool space at transit centers.

Guiding Principles: Public Safety, Accessibility, Consistent and Appropriate Signage, Open Design

Included at: Transit Centers

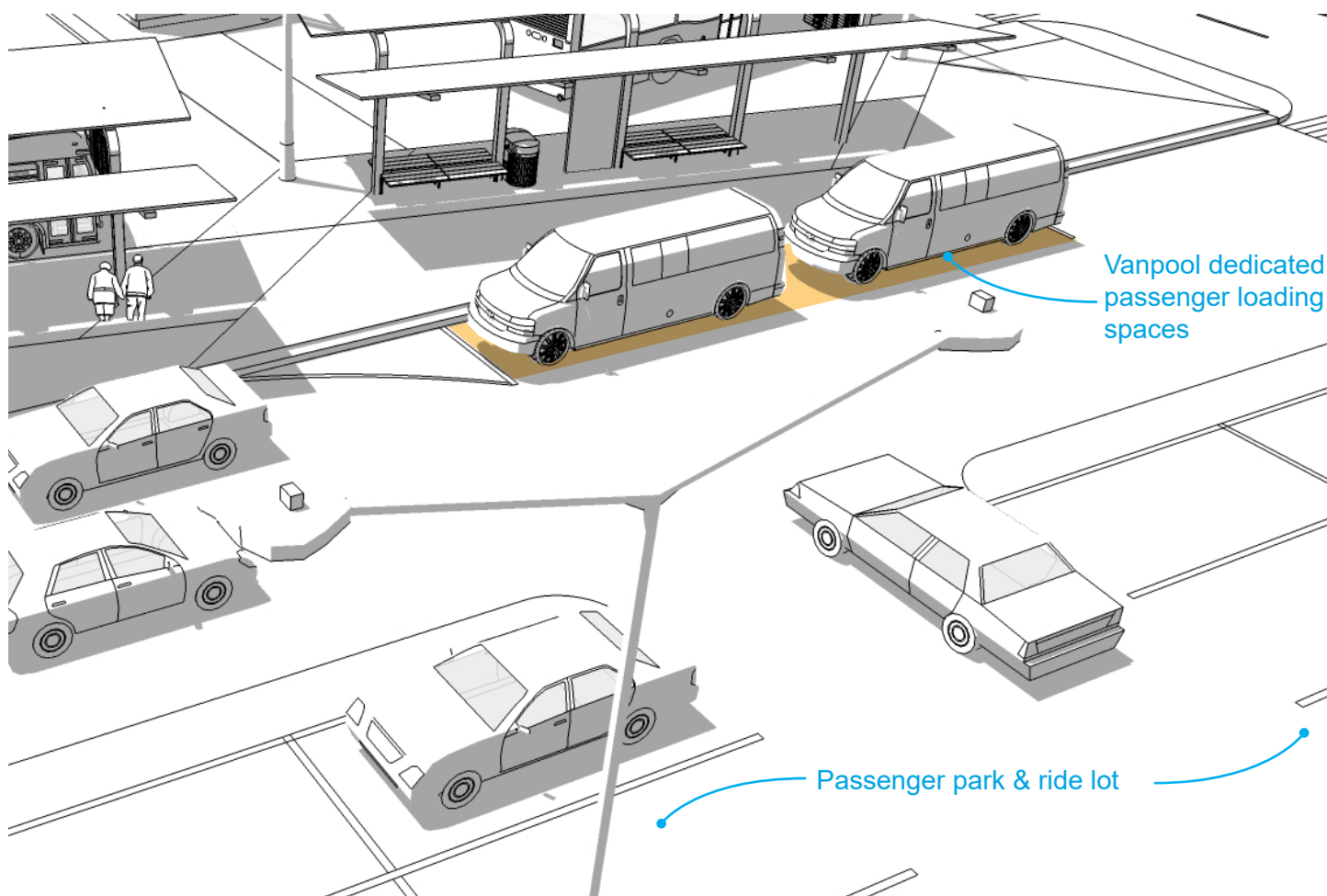

Vanpool designated loading and parking spaces

AMENITIES - PASSENGER PICK-UP & DROP-OFF

Passenger pick-up & drop-off locations, also known as kiss-and-ride, are separate lanes and bays for cars to drop off transit users in a safe and efficient manner. These areas promote ideal utilization of limited space as well as shared trips, with the ability for users to quickly access transit facilities without having a personal vehicle occupy space at a transit center.

WeGo Guidelines

Pick-up and drop-off locations at WeGo transit centers should be designed to be nearby but separate from bus traffic to ensure safety for pedestrians when transitioning from cars to bus platforms. Passenger pick-up & drop-off areas shall comply with ADA regulations such as accessible routes, vehicle pull-up space, and any other applicable sections.

Design Elements

Driveway entrances for buses should be separated from those for other vehicles, so signage should be used at transit centers that incorporate park & ride or other extended capacity for vehicles to clarify this separation. At smaller transit centers, passenger pick-up and drop-off should be incorporated into the perimeter of the site as a bay or cordoned section of on-street parking, preferably on the side street, to allow space for vehicles to move out of the traffic lane. Bollards should be considered in passenger pick-up and drop-off areas to safely separate pedestrians and moving vehicles.

Guiding Principles: Public Safety, Accessibility, Consistent and Appropriate Signage, Open Design

Included at: Transit Centers

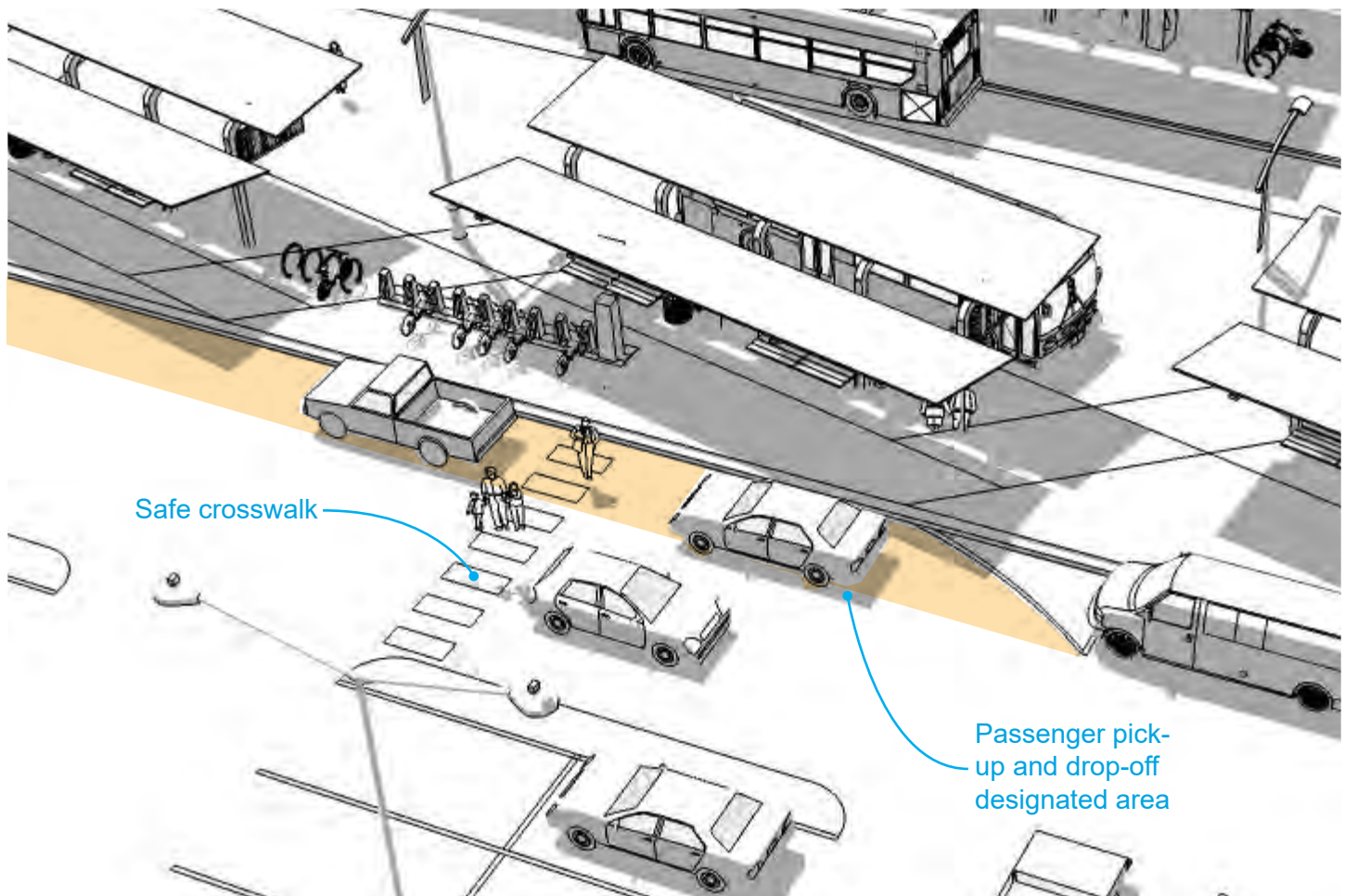

Passenger pickup and drop off loading zone

AMENITIES - TAXI / RIDE SHARE WAITING AREA

Taxis and ride sharing companies offer first- and last-mile options for transit users to complete their trips into surrounding communities. To support this connectivity, space should be provided either on the external perimeter of smaller transit facilities or within parking areas of larger transit facilities.

WeGo Guidelines

Due to their similar nature, it is recommended that taxis and ride share companies share the designated pick up-and drop-off area at smaller transit centers. This planning measure will optimize available space at these locations and create a safe, one stop area for passengers arriving by car. The designated area at smaller centers should be incorporated into the perimeter of the site as a bay or cordoned section of on-street parking, preferably on the side street. Larger centers can incorporate this area into site specific parking space through separate entrances. Signage in this area should direct users to the shared location where cars can queue while waiting for customers. Taxi and ride share waiting areas should include ADA regulations such as accessible routes, vehicle pull-up space, and any other applicable sections.

Design Elements

Other site design improvements such as bollards and security cameras should be located at pick-up and drop-off areas to ensure safety and promote cost savings by incorporating similar uses at one location in the transit center facility.

Guiding Principles: Public Safety, Accessibility, Consistent and Appropriate Signage, Open Design

Included at: Transit Centers

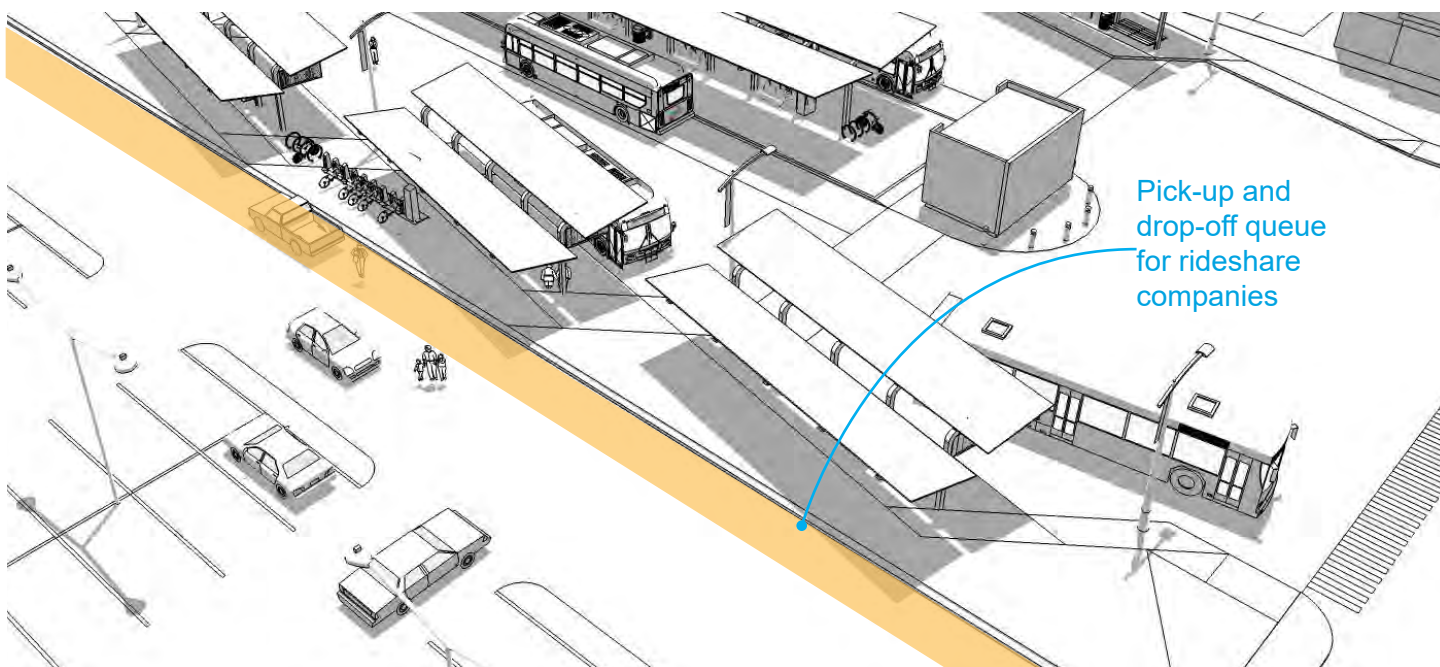

Taxi and ride share loading areas

AMENITIES - SUPPLEMENTAL BUS PARKING

Supplemental bus parking should be incorporated at transit centers to provide space for buses that may be needed in the event of disruptions to scheduled service such as bus breakdowns, or for instances that may require increased service such as concerts or sporting events.

WeGo Guidelines

Supplemental bus parking facilities should be separated from other amenities incorporated at transit centers to prevent confusion and enhance safety.

Design Elements

Bus parking should be adequate for all bus types used by WeGo.

Guiding Principles: Accessibility

Included at: Transit Centers

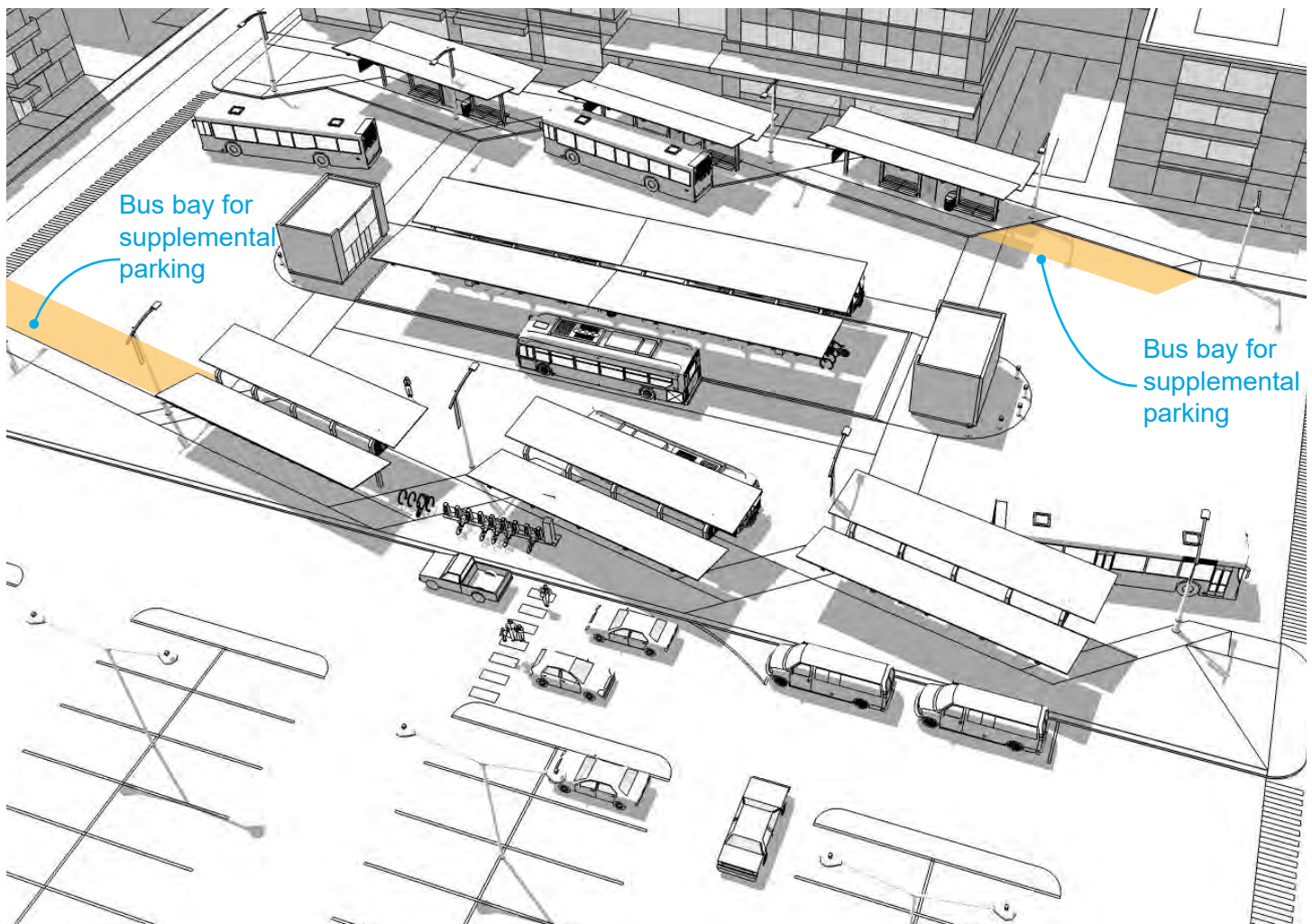

Larger transit center with supplemental bus parking

10

For your safety,
buses do not stop
inside MCC once
they leave their
designated bus
bays.

ENTRANCE

421



4. TRANSIT CENTERS



NEIGHBORHOOD TRANSIT CENTERS

This chapter discusses transit centers, explored through three layers: location, essential components, and expanded sites. Each layer includes an increasing level of detail for the creation of a WeGo transit center. Locating transit centers relies on analysis of WeGo routes and examination of potential qualitative site benefits. Defining basic components quantifies the necessary elements that serve to differentiate the transit center from a typical bus stop. With basic components determined, site-specific improvements can then be added to the transit center using the amenity guidelines laid out in Chapter 3. Note that the elements of universal design and ADA accessibility outlined in Chapter 2 also apply to transit centers.

LOCATION

Transit centers are designed to be a multimodal focal point of transportation. They are typically applied at the junction between local service, rapid service and other modes of transportation at layover stops or transfer points and can be a mixture of on-street stops and off-street bus berths depending on the types of routes served. Transit centers are destination points that can serve as a transportation hub by including connections to park & ride lots, electric vehicle recharging, car-share and bike-share services, greenways, bicycle routes and facilities, and paratransit service. This benefit can only be realized if transit centers are located properly at the convergence of important routes and in areas that will draw riders to utilize them through accessible and safe means. By implementing the following guidelines, WeGo can enhance its ability to choose appropriate sites for transit centers.

GUIDING PRINCIPLES

Locating and selecting sites for transit centers requires a balance between multiple factors. Location can be considered from a broad perspective in terms of how the location fits within the greater WeGo system and from a more focused perspective in terms of how the center fits into the available area and nearby intersections. Below are a set of principles that highlight the system and location-specific considerations that should be made when evaluating the placement of a new transit center.

Route Coordination

Because transit centers are intended to be a multimodal focal point, they should be placed at the intersection of two or more routes. By placing transit centers at locations where higher transit activity is expected, the cost to develop and enhance the stop can be maximized to impact more riders. It also provides a higher quality of service at transfer points.

Reference Metro Planning's *Community Plans and Community Character Manual* for additional guidance in selecting a transit center site.

Neighborhood Context

WeGo's system extends from Nashville's urban core to out-lying suburban towns and communities. In any area throughout the system, a transit center should be located in a neighborhood business district or near an activity center that will help drive ridership and in turn, result in a positive investment for the community. Transit center placement should incorporate neighborhood input and be sited in a way that ensures the transit center can become a focal point within the community. Suggested locations include civic institutions such as universities and hospitals as well as neighborhood business districts and development centers for offices and shopping that have high levels of pedestrian activity to enhance ridership and security at the transit center.

On- or Off-Street Placement

When considering locations for a transit center, the level of development and congestion at the location should be taken into consideration in conjunction with the characteristics of the transit service to determine whether an on-street or off-street center is appropriate. Off-street facilities require more time for the bus to enter and exit the facility, which is affected by the turning requirements, traffic congestion, and internal circulation. This type of site is most appropriate at a location where layovers occur. On-street facilities only require time for boarding and alighting and entering and exiting the traffic stream, which aligns well with rapid service requirements. This type of site would be appropriate at facilities that include parking or off-street passenger pick-up and drop-off because it removes the conflict between circulating buses and passengers walking to and from the parking area.

Efficient Access

When transit centers are constructed as off-site facilities, care should be taken to ensure that the bus operations are not significantly affected by its location. This means making sure driveways are adequately spaced to avoid congestion at the intersection, and that every effort is made to provide convenient access for buses, which means avoiding or mitigating left turns to and from the site as much as possible. If left turns are unavoidable, it is preferable to coordinate with a signalized intersection from the main street to a side street access point with more opportunities for accessible gaps.

NEIGHBORHOOD TRANSIT CENTERS

The following guidelines should be considered when determining the location of transit centers:

- Transit centers should ideally be placed at the corner of an intersection to coordinate transfer activity. In instances where corner parcels are unavailable, partnership with nearby activity centers such as malls or other institutions should be explored.
- Transit centers should be placed with consideration to potential population growth and service expansion.
- When located at activity centers, transit centers must successfully blend with the existing landscape, meaning safe connections for pedestrians through extending sidewalks and paths, seamless ingress and egress for buses and cars to the street grid, and appropriate sizing that fits with the scale of the surrounding activity center.
- Access points for buses and personal vehicles should adhere to local and state guidelines for access management and driveway spacing to provide room for maneuvering and reduce crashes related to closely spaced driveways.
- It is preferred that the access for buses and other vehicles be separated.

ESSENTIAL COMPONENTS

Establishing a transit center is a complex process that considers differing routes, frequencies, types of bus, pedestrian connectivity, and connecting streets. Transit centers will consist of a standard set of components that provide an identity separate from local and rapid stops, though the extent of the available site will dictate the limits of the components at the center. The primary building block of a transit center is the bus platform. Transit center platforms are generally longer, contain larger areas for waiting and have a canopy as opposed to a bus stop shelter. At a minimum a neighborhood transit center should include:

Table 10 - Transit Center Essentials

Benches	Canopies	System Maps and Information	Surveillance Cameras	Climate Controlled Waiting Area
Trash Receptacles	Site Lighting	Local Area Maps and Wayfinding Guidance	Call Box/Emergency Buttons	Ticker Vending Machines
Next Bus Signs	Service Timetables	Integrated Advertisements	Employee Restrooms	Employee Breakroom

Though a neighborhood transit center can take on many forms based on the local conditions, **Figure 14** shows an example of what a basic neighborhood transit center might look like. These smaller neighborhood centers generally encompass at least 1.5 to 2 acres.



Figure 14 - Basic Neighborhood Transit Center

Table 11 - Smaller Transit Center Optional Amenities

Bicycle Racks	Wi-Fi Hotspots	Public Art
Bicycle Lockers	Rideshare Company Waiting Area	Landscaping
Shared Mobility Area	Passenger Pick Up & Drop Off	Vendor Space

NEIGHBORHOOD TRANSIT CENTERS

The application of these additional amenities should correspond to the size of the site, the number of routes, the ridership and the opportunities for capturing other multimodal users. The layout should align with principles of safety and accessibility, as discussed below.

GUIDING PRINCIPLES

Transit centers will incorporate many of the same elements as bus stops in addition to amenities that enhance its service as a multi-modal hub. As discussed in the section above, location will play a large role in the configuration of basic components at a transit center. When determining the configuration of the site and its amenities, the following principles should be taken into consideration.

Right-Sizing Elements

To ensure the best return on investment for WeGo, factors that will affect service and ridership need to be analyzed prior to implementing basic components in order to determine the appropriate installation that corresponds with the type and frequency of service. Over time, this will lead to cost-savings and suitable use of the site, with savings on maintenance and replacement through appropriate utilization of transit center components.

Safety and Accessibility

Determining the components of a transit center also provides an opportunity to assess safety and accessibility in the design. The placement of transit center components throughout the site should enhance pedestrian connectivity and safe separation of the different modes using the transit center. Consideration of ADA design guidelines and efficient accessibility should be prioritized in the development of site components.

Enhance User Comfort

Amenities added to a transit center should always enhance the transit user's comfort. While not all transit centers will exhibit the same amenities, the goal of enhancing comfort will be maintained across the system and be molded to fit the needs of different user groups. For example, a more urban transit center may include bicycle lockers due to its proximity to bicycle infrastructure while a suburban transit center may include a park & ride lot due to its proximity to a more car-reliant population.

Unique Passenger Experience

Transit centers also offer an opportunity to significantly enhance the WeGo experience through the addition of unique amenities. As connection points throughout the city, transit centers will be able to offer multiple modes that differentiates them from other bus stops. Amenities such as bicycle lockers, vendor space, and wayfinding information add significant value to the user's experience and helps enhance the perception of WeGo as a unique transportation alternative.

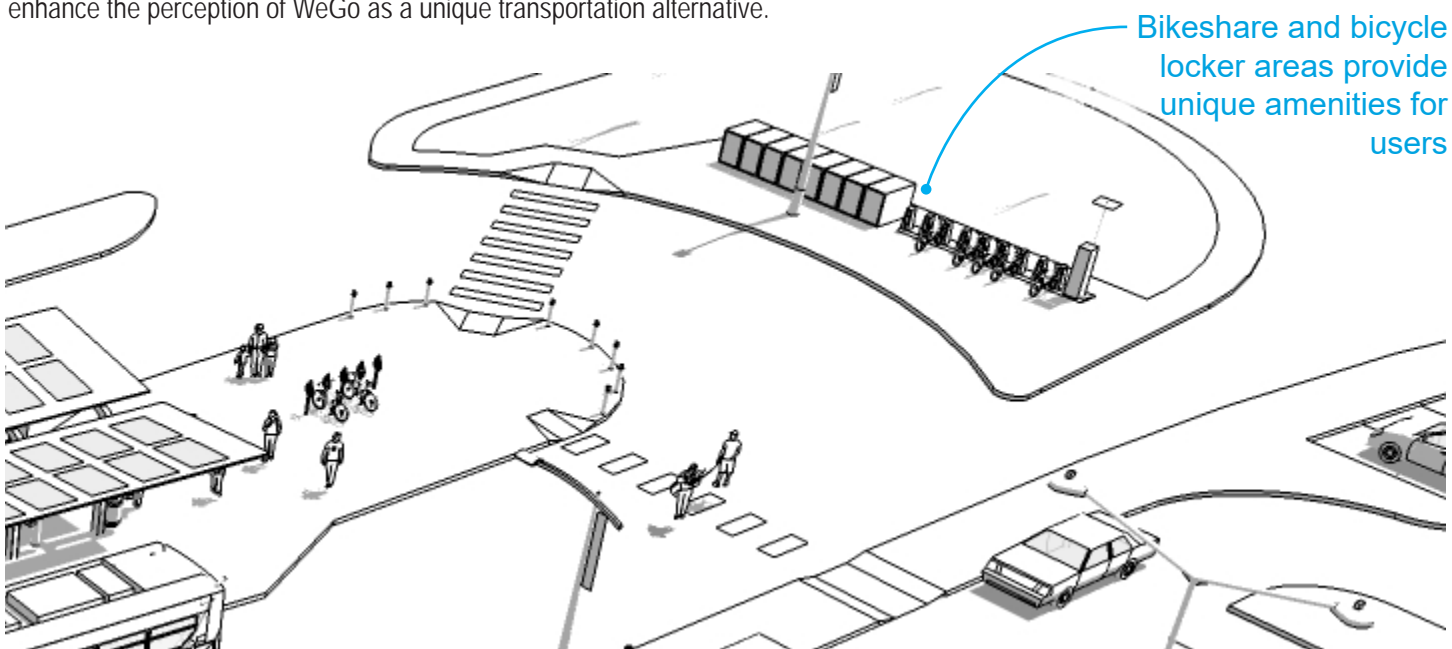

NEIGHBORHOOD TRANSIT CENTERS

The following guidelines should be considered when designing transit centers:

- The context of the site location will inform decisions regarding bicycles, wayfinding, and vendor space.
- The number and frequency of buses utilizing the center will determine the number of berths required. Depending on the frequency and expected length of layover time, one berth per route may be necessary.
- Rapid service routes should not be directed into an off-street site unless the transit center is located at a layover stop. The rapid service route should be incorporated into the center via a connected curbside stop.
- Interior circulation should provide enough width for two buses to prevent blockage in the event of a bus breakdown.
- Bus berths should be designed for passenger boardings and alightings on the right side of the bus where doors are located.
- Bus bays should be clearly marked with appropriate WeGo signage and should include real time bus displays at each berth.
- Pedestrian crossings within the bus lane should be avoided; however, if the design requires pedestrian crossings in bus lanes (such as a central island design), crosswalks should be located at the end of the island rather than in the middle to reduce conflict with bus operation and increase pedestrian visibility.
- If sawtooth berths are used, the design should adhere to **Figure 15** below, including the placement of bollards at the front of the berth.
- If parallel berths are used, platform lengths will vary depending on the route and bus types utilizing the transit center.
- Landscape improvements should require as little maintenance as possible without sacrificing quality.
- Public art installations should follow all applicable WeGo and other relevant department regulations.

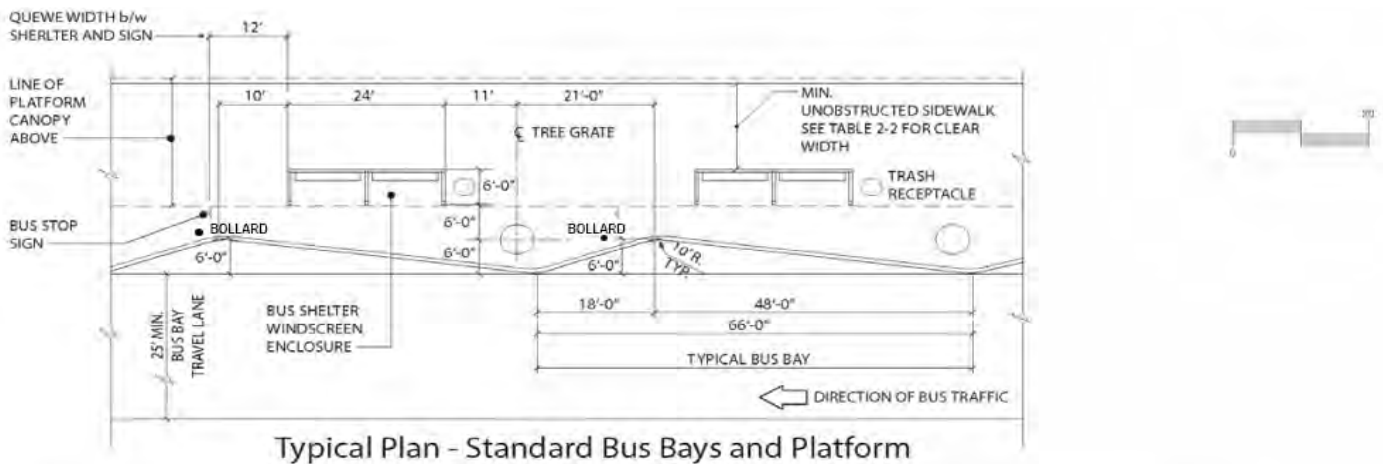

Typical Plan - Standard Bus Bays and Platform

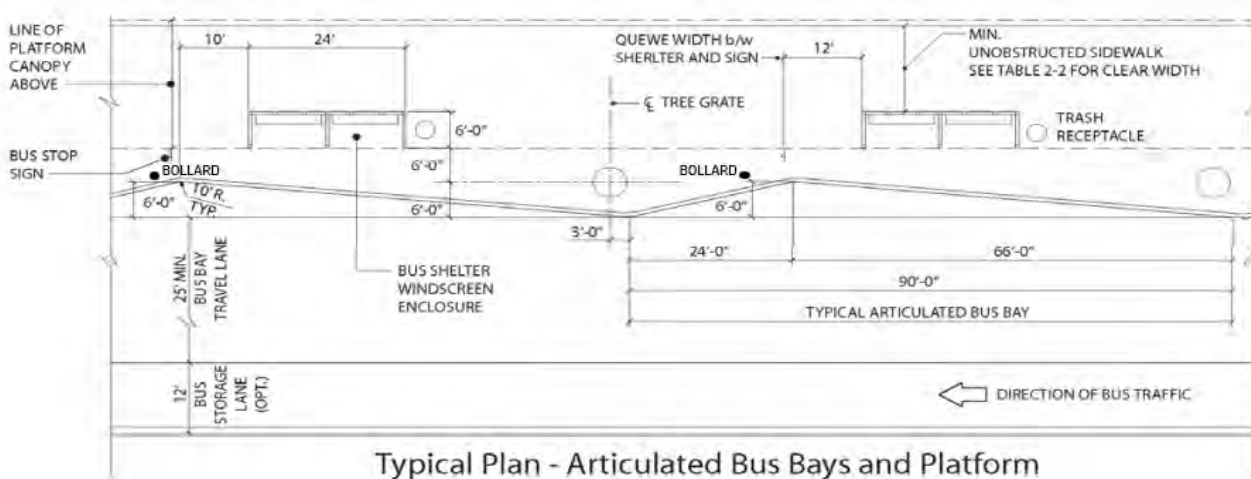

Typical Plan - Articulated Bus Bays and Platform

Figure 15 - Transit Center Platform Layouts

TRANSIT CENTERS - EXPANDED SITES

Larger transit centers offer opportunities to provide additional benefits such as accommodations for personal vehicles and other unique amenities. A larger transit center footprint provides the necessary space for these improvements. These amenities may include:

Table 12 - Larger Transit Center Optional Amenities

Park & Ride Lot	Car Charging Stations
Van Pool Parking	Employee Restrooms
Bus Charging Station	Climate Controlled Waiting Areas
Car Share Stations	

GUIDING PRINCIPLES

Expanded sites should be utilized at the terminus points of routes or larger transfer areas where more users will arrive by car or experience waiting periods. This allows expanded sites to act as a gateway for the user to the WeGo system, either departing, arriving, or transferring.

Transit Gateways

Providing space for park & ride facilities, van pool access and places to charge electric vehicles provides an alternative to using personal vehicles as well as a focal point to capture ridership in less densely populated areas. In this way the transit center can serve as a gateway to transit ridership.

GUIDELINES

The inclusion of these amenities is intended to attract ridership by enhancing the system's ease of use for the rider and creating more convenient access as an alternative mode to personal vehicle travel. The following guidelines should be considered when determining additional improvements at transit centers:

- Access to park & ride and vanpool space should be separate from transit center entrances to maintain efficient transit operations, minimize conflicts and avoid interfering with the visibility between the loading zone and the parking lot.
- Pedestrian crosswalks to and from park & ride and vanpool should avoid crossing the bus lane; however, if the design requires pedestrian crossings in bus lanes (such as a central island design), crosswalks should be located at the end of the island rather than in the middle to reduce conflict with bus operation and increase pedestrian visibility.
- Barrier separation between bus lanes and pedestrian space should be considered to direct the flow of pedestrian traffic.

When incorporating park & ride and vanpool facilities, sizing the facility is important to maximize the efficient use of the space. Lots that are too small may not justify the cost of the facility and operations, while lots that are too big require long walking distances. Park & ride lot size should conform to the level of service and user base at each stop, as each stop will have unique site constraints and ridership.

TRANSIT CENTERS - EXPANDED SITES

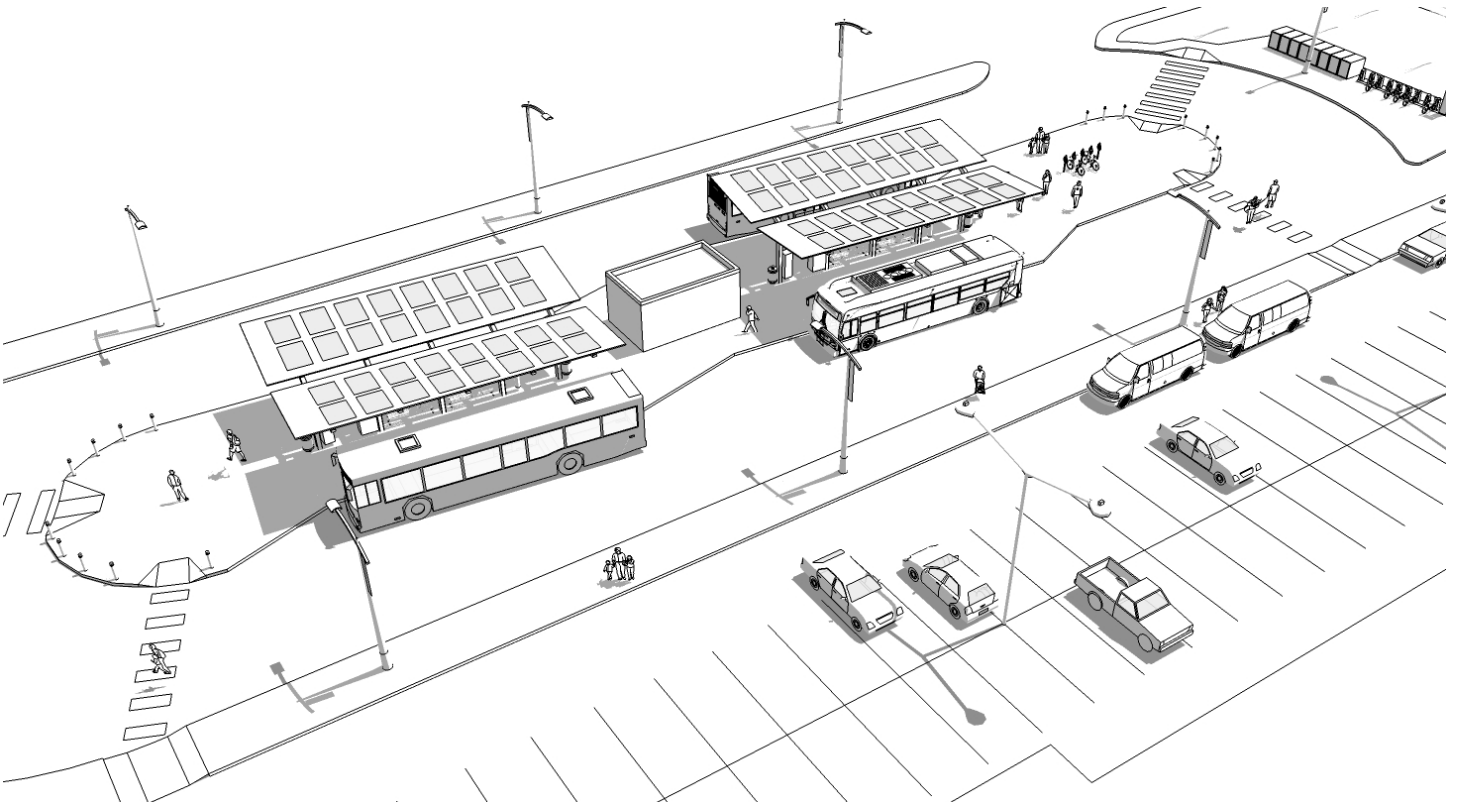
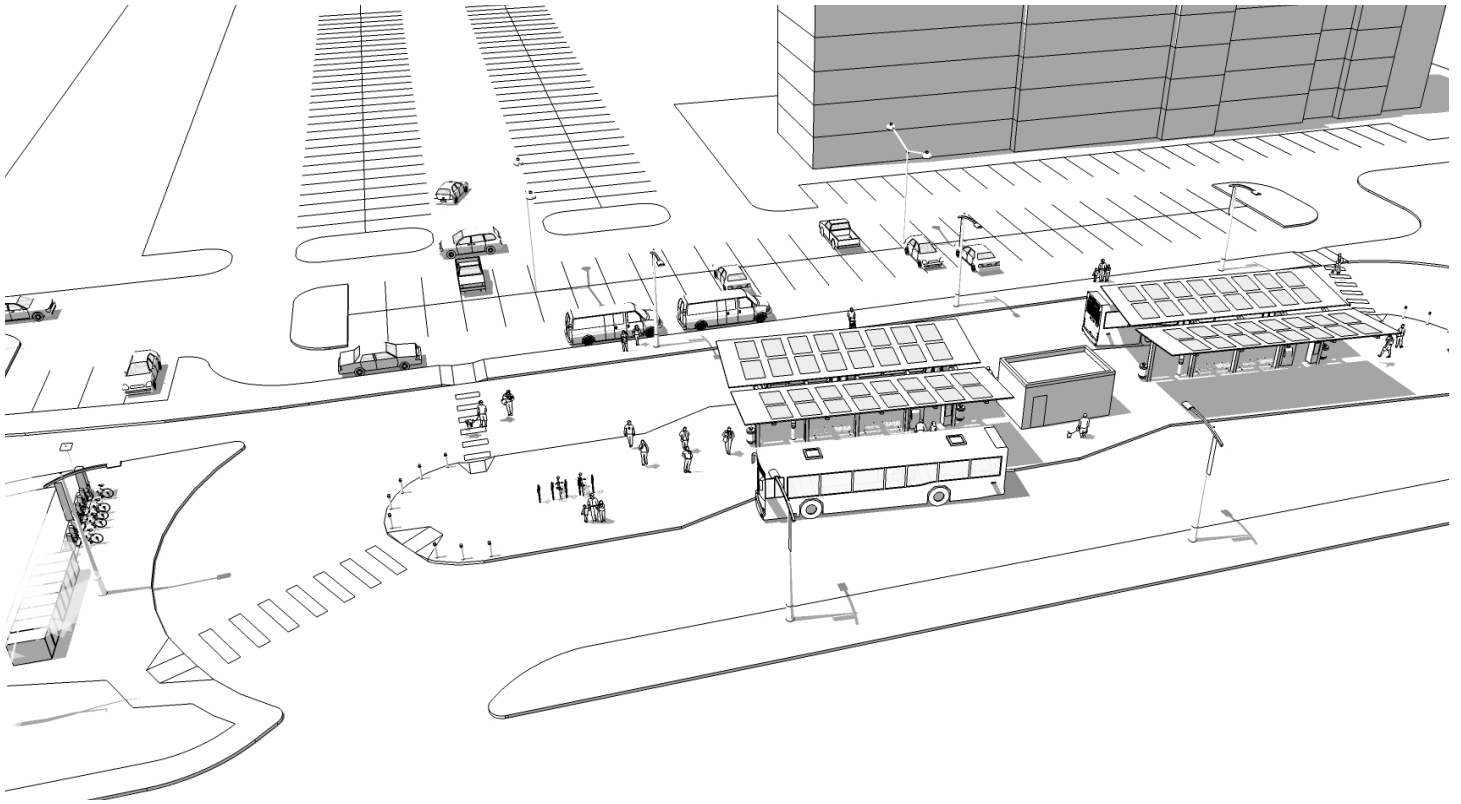

Expanded Transit Center sites

WeGo Public Tran



isit

APPENDIX A



ADA GUIDELINES

WeGo bus stops and transit centers are required to follow the latest ADA Standards related to transportation facilities. The 2010 Standards are referenced and current as of the publishing of these guidelines. The references to these standards are not intended to be all encompassing but rather act to direct the user of the guidelines to areas of ADA that may need to be incorporated when implementing amenities and elements at bus stops and transit centers.

Guidelines that apply to the general design and layout of a stop are introduced first, as the application of these specific guidelines will occur repeatedly throughout stop design and implementation. Individual amenities are then presented with related ADA sections.

Accessible Routes

ADA guidelines related to accessible routes are included in Chapter 2 Scoping Requirements, 206 Accessible Routes and Chapter 4 Accessible Routes.

Chapter 2, 206 details where accessible routes are required while Chapter 4 includes more details on walking surfaces, doorways, and curb ramps that may be incorporated at WeGo sites.

Building Blocks

Chapter 3 Building Blocks, illustrates how to apply ADA standards to provide necessary space and usability for passengers. Important sections in this chapter include 302 Floor or Ground Surfaces, 303 Changes in Level, 304 Turning Space, 305 Clear Floor or Ground Space, 306 Knee and Toe Clearance, 307 Protruding Objects, 308 Reach Ranges, and 309 Operable Parts. Many of these components play a part in the design and layout of a bus stop or transit center, as different elements can affect the applicability of certain ADA standards.

Amenities

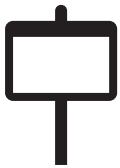

Bus Stop Signs

Signs should follow 810.4 which references the user to section 703 Signs, where other requirements are listed.

Emergency Call Boxes

Emergency telephones installed at transit centers should follow section 704.



Benches

Benches used at WeGo stops should follow section 903 Benches.

Employee Restrooms

Employee restrooms require multiple considerations under ADA. Sections to examine include 404, 603, 605, 606, and 703.



Shelters

Shelters should follow the requirements listed under section 810.3

Parking Areas

Parking areas tied to Park & Rides at transit centers should follow section 502 related to handicap parking spaces.



Real-Time Bus Displays

Transit centers and stops that use real-time bus displays should follow section 810.8.

Passenger Pick-Up and Drop-Off Areas

Loading areas for passengers should follow section 503.



CURRENT SERVICE TYPES

WeGo SERVICE

WeGo currently utilizes five different route types. This section can be updated as new route types are added or removed to provide context for destinations and service areas. An example of each route type used in the current system is provided below.

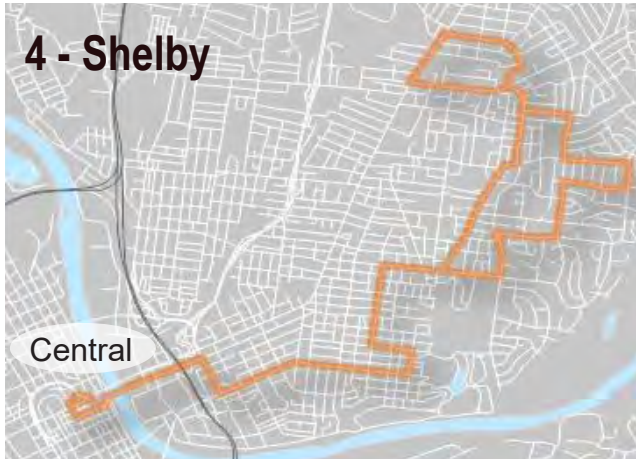

Local Service

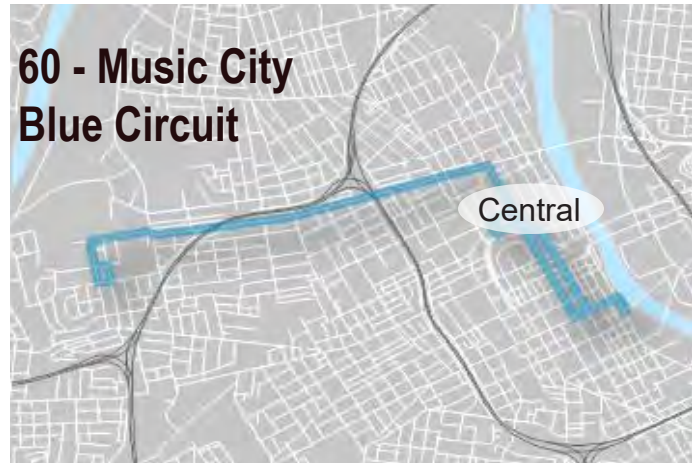

Circulator Service



Express Service

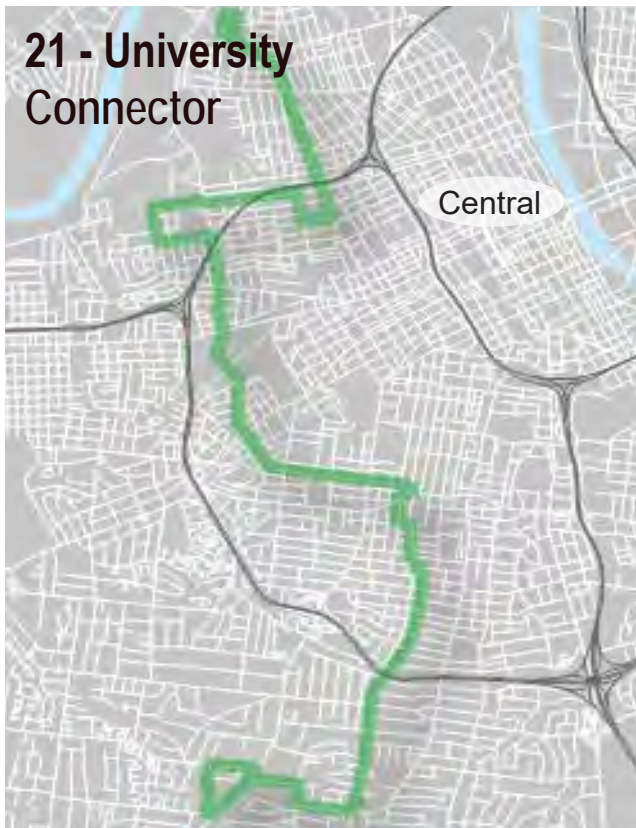

Connector Service

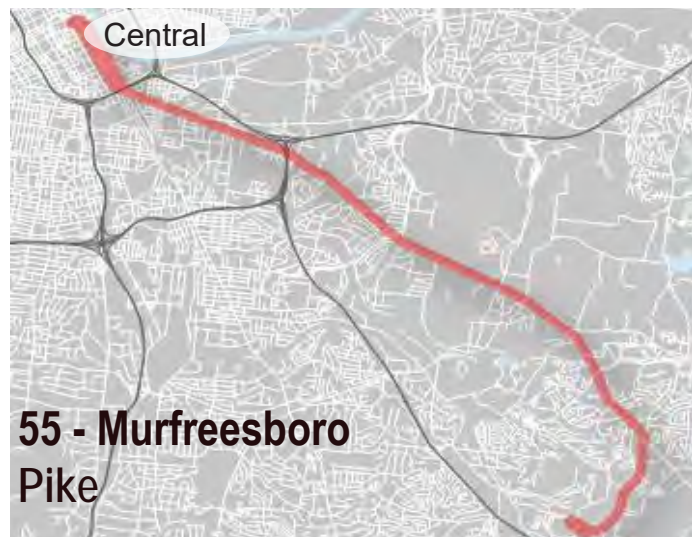

Rapid Service

VEHICLE INFORMATION

To design facilities for buses, it is important to know the specifications of the design vehicles using the facilities. WeGo currently uses four sizes of bus in its fleet: 35- and 40-foot standard buses, 45-foot buses for express service, and 60-foot articulated buses. Elements of the bus such as wheelchair ramp location, door spacing, and bike racks need to be considered when designing bus facilities to ensure coordination. Critical dimensions for each bus are provided below for reference. Designers should verify with WeGo that they have the most current bus specifications prior to initiating the design of a bus facility.

Minimum turning paths are also important design considerations as they affect the space required to accommodate the bus. Turning path templates can assist in determining the proper intersection curve radii and show how the bus may encroach into adjacent lanes or curbside space. To examine turn path templates for each bus type, refer to the latest edition of AASHTO's A Policy on Geometric Design of Highways and Streets. It should be noted that the outer turn radii shown in the turning path templates include accommodation for the clearance of bike racks attached to the front of the bus.

Bus Information

Manufacturer	Gillig 35 ^A	Proterra	Gillig 40 ^B	MCI D45	New Flyer (2 Door) ^C	New Flyer (3 Door) ^D	Glaval (Paratransit)	Starcraft (Paratransit Low Floor)
Full Length	36' 2 1/2"	34' 9"	41'	45' 7"	60' 10"	60' 10"	24' 6"	25' 11 1/2"
Wheel Base	19' 7"	19' 8"	23' 8"	26' 3"	43' 6 1/2"	43' 6 1/2"	14' 8"	14' 8"
Front Door to Bumper	1' 10 1/2"	1' 4"	2'	2'	1' 5"	1' 5"	5' 3"	8' 4"
Rear Door to Bumper	16' 3"	18' 4"	16' 6 1/2"	N/A	13' 6 1/2"	13' 6 1/2"	19' 1"	N/A
Centerline Door to Door	14' 11"	13' 11"	19' 9"	N/A	39' 6"	14' 8" Front to Mid; 24' 10" Mid to Rear	14' 2"	N/A
Door Width (Front)	3' 4"	2' 9"	3' 3"	2' 6"	3' 4"	3' 4"	3' 5"	2' 10"
Door Width (Rear)	4'	2' 6 1/2"	2' 11"	3' 7 1/2"	4' 4"	4' 4" (both)	3' 11"	N/A
Turning Radius	36'	36'	43'	40' 11"	44'	44'	60' 3"	60' 3"
Height	9' 8"	11' 1"	9' 8"	11' 6"	10' 10"	10' 10"	9' 6"	9' 6"
Wheel Chair Ramp	Front	Front	Front	Middle	Front	Front	Rear	Front
Bike Rack	Yes	Yes	Yes	No	Yes	Yes	No	No

TURNING RADIUS and LOADING AREAS

This section is intended to guide WeGo staff and their consultants in designing bus stops that are appropriate for the service being provided. Multiple combinations of stop type and service type are possible, but funding and space limitations make it important to design a stop that maximizes the impact and cost-effectiveness of the investment in the stop. The diagrams below relating to turning radius and loading areas help illustrate the minimum and maximum swept path available in WeGo's bus fleet as well as the potential loading areas that are necessary based on the types of bus serving a stop.

Turning Radius

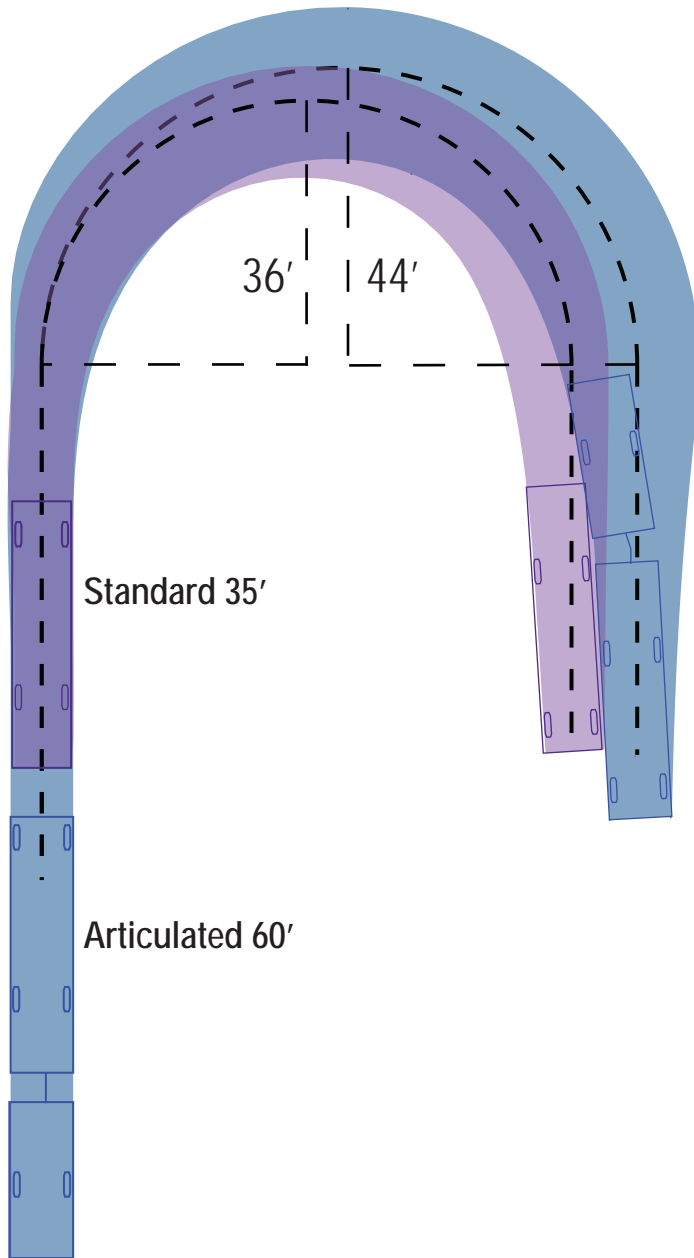

Loading Areas

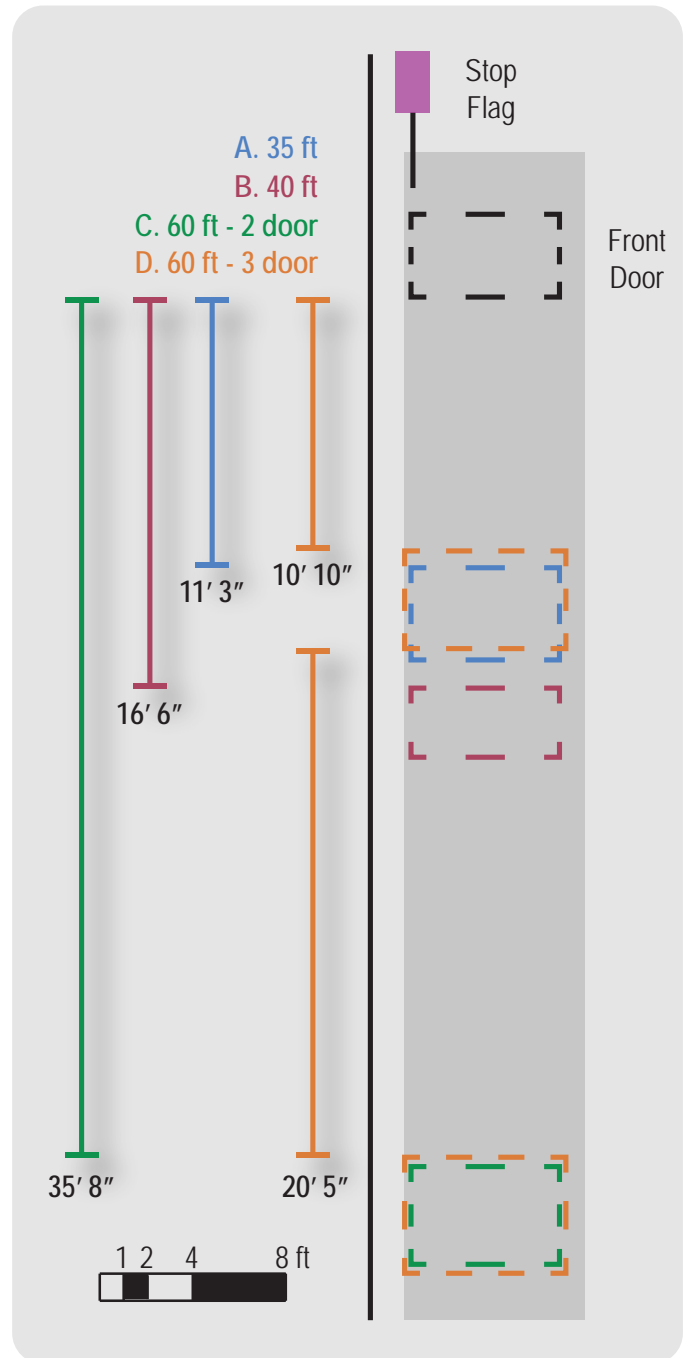

WeGo BUSES

A. - Gillig - 35'

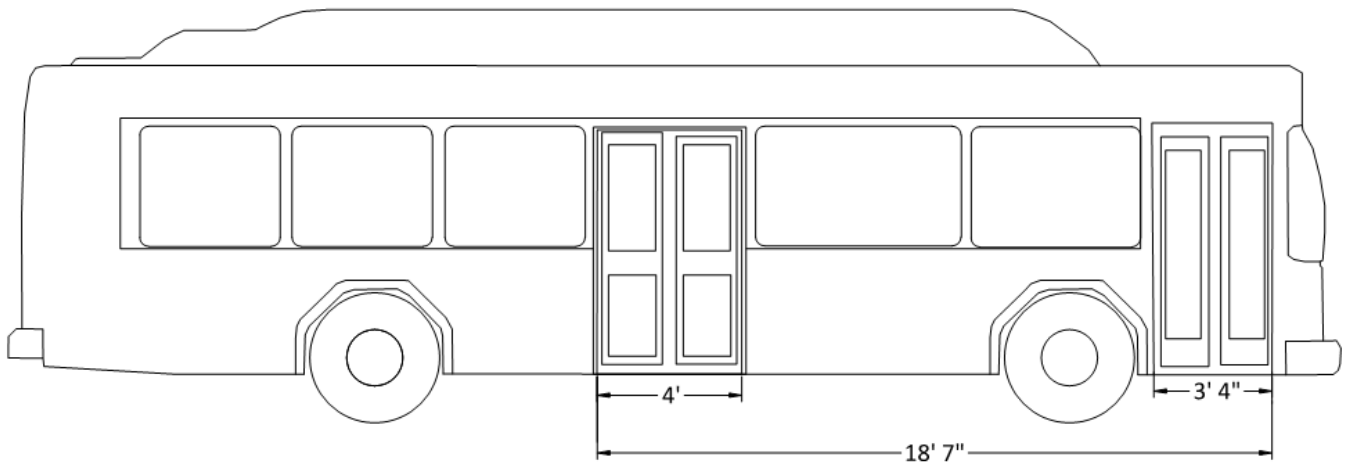

B. - Gillig - 40'

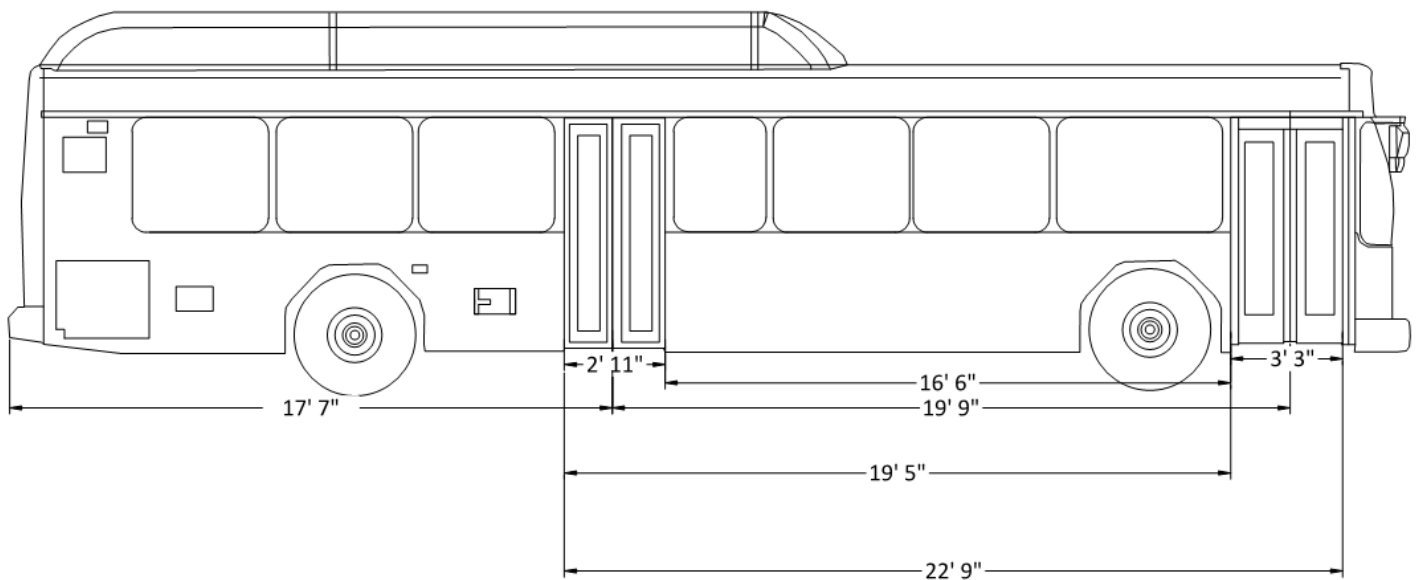

WeGo BUSES

C. - New Flyer - 60', 2 Door

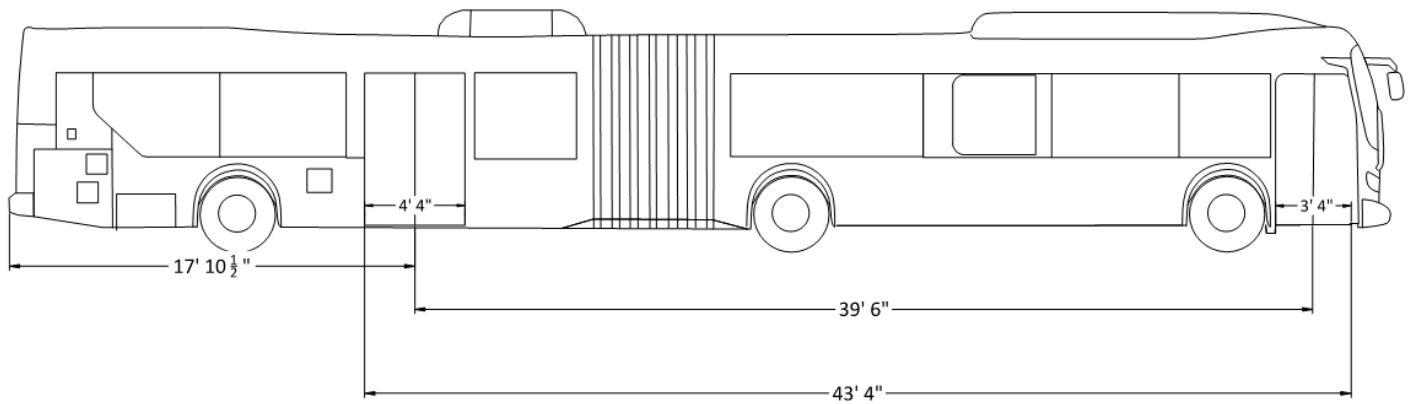

D. - New Flyer - 60', 3 Door

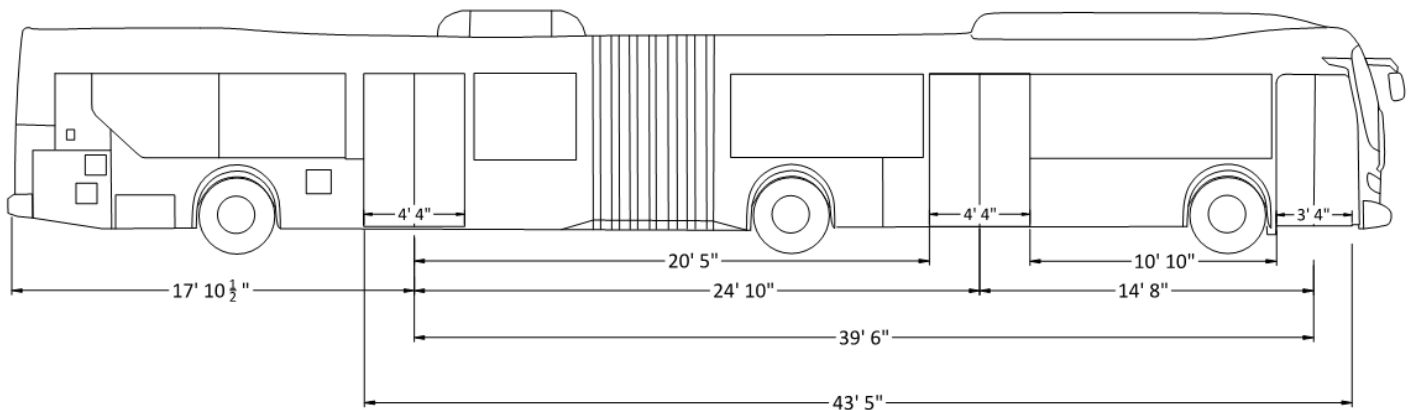

IMAGE CREDITS

Images are listed by order of appearance with caption used as reference. Order of attribution: author, link, and any modifications. Images with attribution other than WeGo or CDM Smith are licensed under Creative Commons (CC BY 2.0, CC BY 3.0, or CC BY 4.0). All chapter heading photographs via WeGo.

CHAPTER 1

WeGo Service

- WeGo

WeGo Service at Transit Center

- WeGo

WeGo Service Objectives

- WeGo

CHAPTER 2

Tactile warning

- ADA Solutions, Inc. adatile.com

Bus stop lighting

- CDM Smith

Curbside Stop with Cycle Lane

- City of Toronto, <https://flic.kr/p/ESTXp6>. Cropped original image.

Curbside Raised Cycle Lane

- City of Toronto

CHAPTER 3

Bus stop with shelter canopy, seating, and signage

- Philip Terry Graham, commons.wikimedia.org/wiki/File:Mulga_Road_at_River_Road_Bus_Stop_at_Oatley_Station,_December_2016.jpg. Original image resized.

Bus stop with bollard-protected boarding area

- Steven Vance, www.flickr.com/photos/jamesbondsv/33033548643. No changes to original.

Open shelter for ease of seeing approaching bus

- Pixabay, Public Domain

Bus stop with ramp and warning strip

- glasseyesview...up&away, flic.kr/p/bnSt7D. Cropped original image.

Bus stop with passenger seating

- Elvert Barnes Photography, www.flickr.com/photos/perspective/30364754440. No changes to original.

Directional arrows and signage to street

- CDM Smith

Consistent color use on bus and station signage

- GHN83613, commons.wikimedia.org/wiki/File:Express_bus_at_KGH_bus_stop.jpg. No changes to original.

Transit center with transparent canopy

- David Wilson, www.flickr.com/photos/davidwilson1949/36852616820/in/photostream/. No changes to original.

Transit stop with well-arranged amenities

- time anchor, <https://flic.kr/p/9SQaKy>. No changes to original.

Standard shelter stop components

- nacto.org Bus bulbs image

Cleaning and maintenance at stop

- Tiia Monto, commons.wikimedia.org/wiki/File:Bus_stop_cleaning.jpg. No changes to original.

Transit center illustrating various amenities

- SounderBruce, upload.wikimedia.org/wikipedia/commons/4/49/Overlake_Transit_Center_bus_bays.jpg. Cropped original image.

Single route sign example

- WeGo

Multi-route sign example

- WeGo

Circuit route sign example

- WeGo

WeGo bench with advertisement

- WeGo

WeGo shelter bench

- CDM Smith

Current WeGo trash receptacle

- CDM Smith

IMAGE CREDITS

Current WeGo bike rack

- CDM Smith

Site lighting from shelter and existing light sources

- CDM Smith

Next bus display types 1

- Public Domain

Next bus display types 2

- Estoy Aqui, commons.wikimedia.org/wiki/File:Dublin_Bus_rtpi.jpg. Cropped original image.

Bench advertisement

- CDM Smith

Advertisement area

- CDM Smith

Canopy shelter utilizing durable materials

- Oran Viriyincy, [flickr.com/photos/viriyincy/3954675628](https://www.flickr.com/photos/viriyincy/3954675628). Cropped original image.

Local area map

- http://ridegrtc.com/media/news/IMG_2340.JPG

Wayfinding post

- Oran Viriyincy, [flic.kr/p/79DHoF](https://www.flickr.com/photos/viriyincy/79DHoF). Cropped original image.

Ticket vending machine at Central

- CDM Smith

Alternative vending machine style

- MTA / Patrick Cashin, [https://flic.kr/p/hDV4d1](https://www.flickr.com/photos/p/hDV4d1). No changes to original

Bicycle locker design

- dero.com/product/dero-bike-locker-33/

Emergency call button

- Rusty Clark, [flic.kr/p/aa489Y](https://www.flickr.com/photos/viriyincy/aa489Y). Cropped original image.

Climate-controlled waiting area at a transit center

- Jim.henderson, commons.wikimedia.org/wiki/File:GWB_Bus_Station_waiting_room_jeh.jpg. Original image cropped to fit page.

Potential restroom facility at a transit center

- An Errant Knight, commons.wikimedia.org/wiki/File:Timpanogos_Transit_Center_east_side.JPG. Cropped original image.

Small vendor kiosk in public space

- Thelmadatter, commons.wikimedia.org/wiki/File:CrepeStandCCM.JPG. Cropped original image

Well-protected boarding area with bollards

- Tdorante10, commons.wikimedia.org/wiki/File:Jamaica_LIRR_94th_St_Bus_Stop_01.JPG. No changes to original.

Low-maintenance and drought-tolerant plantings

- Steve Morgan, commons.wikimedia.org/wiki/File:Sunset_Transit_Center_in_2011.jpg. Cropped original image.

Creative bike rack

- Don O'Brien, [flic.kr/p/czyve5](https://www.flickr.com/photos/dobrien/czyve5). Cropped original image.

Public art serving as a canopy

- cheriejoyful, [flic.kr/p/a9HN9P](https://www.flickr.com/photos/cheriejoyful/a9HN9P). Cropped original image.

Mural

- SounderBruce, [flic.kr/p/FoGFhW](https://www.flickr.com/photos/sounderbruce/FoGFhW). Cropped original image.

Bikeshare station near a bus stop

- CDM Smith

Designated car share parking space

- GoToVan, [flic.kr/p/KqF2Dk](https://www.flickr.com/photos/gotovan/KqF2Dk). Image resized.

Car chargers at nearby parking spaces

- felixkramer, [flic.kr/p/61QiFH](https://www.flickr.com/photos/felixkramer/61QiFH). Cropped original image.

Overhead bus charging stations

- Misanthropic One, [https://flic.kr/p/NoDSJy](https://www.flickr.com/photos/misanthropicone/NoDSJy). No changes to original.

S STATION

WeGo Public Transit

WeGo



APPENDIX B



© 2012 CDM SMITH ALL RIGHTS RESERVED. REUSE OF DOCUMENTS: THESE DOCUMENTS AND DESIGNS PROVIDED BY PROFESSIONAL SERVICE, INCORPORATED HEREIN, ARE THE PROPERTY OF CDM SMITH AND ARE NOT TO BE USED, IN WHOLE OR PART, FOR ANY OTHER PROJECT WITHOUT THE WRITTEN AUTHORIZATION OF CDM SMITH.

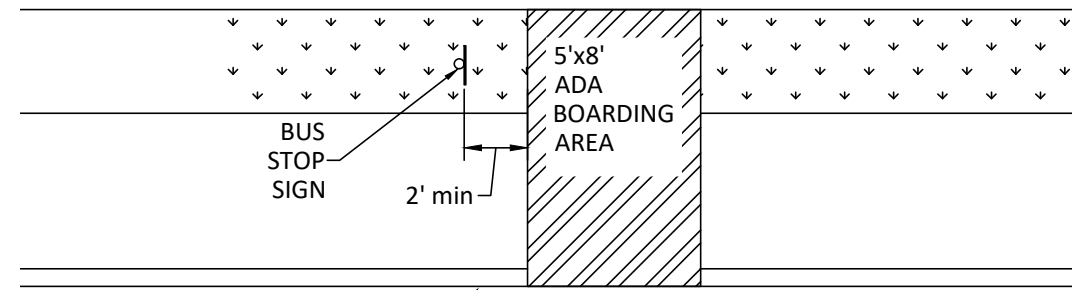

SIDEWALK ATTACHED TO CURB

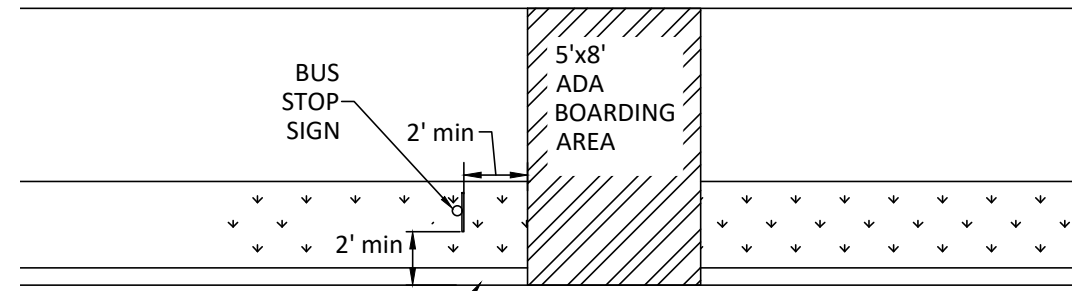

SIDEWALK DETACHED FROM CURB

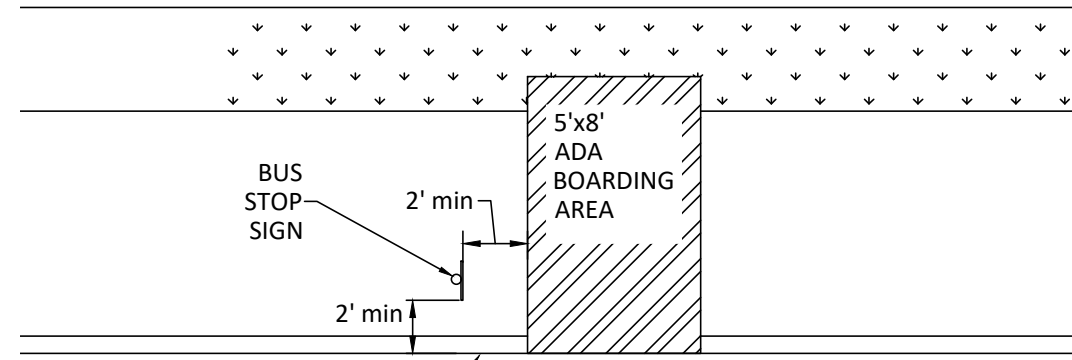

WIDE SIDEWALK ATTACHED TO CURB

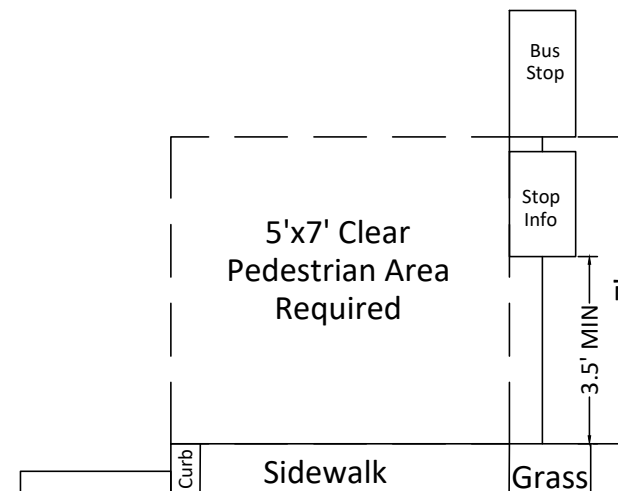
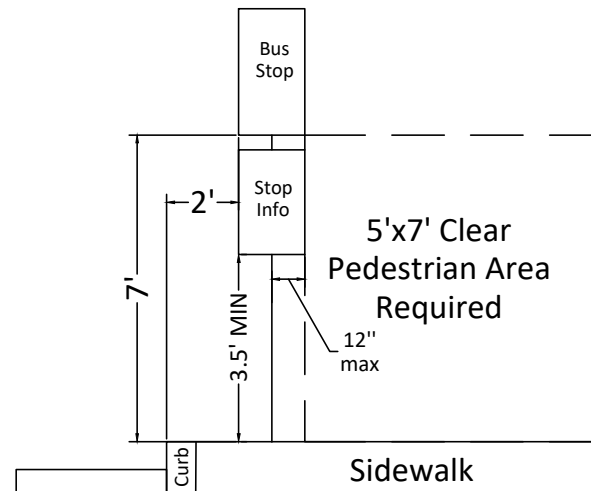
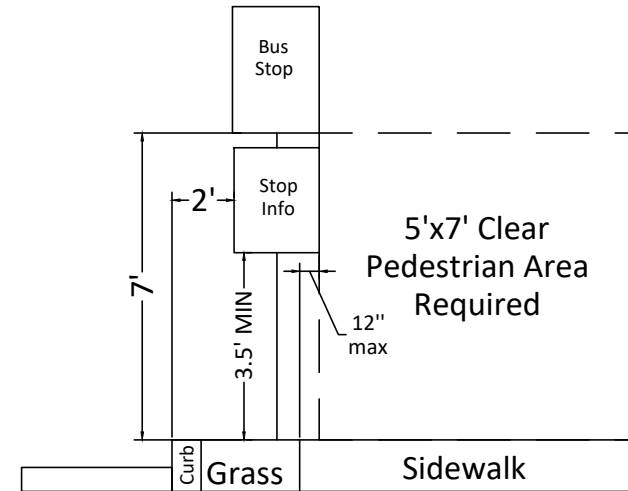

- GENERAL NOTES
- (A) FOR SPECIFIC CONDITIONS NOT COVERED ON THIS SHEET, REFERENCE SHOULD BE MADE TO THE DESIGN GUIDELINES REPORT.
 - (B) DESIGN STANDARDS SHOWN IN THIS LAYOUT ARE REFERENCED FROM STATE OF TENNESSEE DEPARTMENT OF TRANSPORTATION AND NASHVILLE METRO PUBLIC WORKS STANDARD DRAWINGS, AS WELL AS 2010 ADA STANDARDS FOR ACCESSIBLE DESIGN. CURRENT STANDARDS SHOULD BE REVIEWED FOR COMPLIANCE BEFORE STOPS ARE INSTALLED OR MODIFIED.
 - (C) DESIGN GUIDELINES SHOWN IN THIS LAYOUT ARE REFERENCED FROM NACTO'S 2016 TRANSIT STREET DESIGN GUIDE AND THE TRANSIT COOPERATIVE RESEARCH PROGRAM REPORT 19 - GUIDELINES FOR THE LOCATION AND DESIGN OF BUS STOPS. CURRENT DESIGN GUIDELINES SHOULD BE REVIEWED FOR COMPLIANCE BEFORE STOPS ARE INSTALLED OR MODIFIED.
 - (D) ALL SIGNS, SYMBOLS, MARKINGS AND THEIR SPACING SHOULD ADHERE TO MUTCD, STATE AND LOCAL GUIDANCE.
 - (E) TO PREVENT THE BUS STOP SIGNS FROM BEING STRUCK BY MIRRORS, ALL SIGNS SHOULD BE A MINIMUM OF 24 INCHES (2 FEET) FROM THE FACE OF THE CURB.
 - (F) THE BUS STOP SIGN SHOULD BE LOCATED AT THE FRONT OF EACH BUS ZONE, TO LOCATE THE APPROXIMATE STOPPING POINT FOR THE FRONT OF THE BUS.
 - (G) THE 5'X8' ADA BOARDING AREA SHOULD ALIGN WITH THE WHEELCHAIR LOADING POSITION OF ANY BUS IN MTA'S FLEET THAT WOULD TYPICALLY BE ASSIGNED TO THAT ROUTE.

- FLAG STOP NOTES
- ① THE BUS STOP SIGN SHOULD BE INDEPENDENT OF ALL OTHER STREET SIGNS TO MAINTAIN TRANSIT STOP IDENTITY.
 - ② THE BUS STOP SIGN MUST BE CLEARLY VISIBLE TO THE APPROACHING BUS DRIVER AND SHOULD NEITHER BLOCK NOR BE BLOCKED BY OTHER JURISDICTIONAL SIGNS OR ANY OTHER OBSTRUCTIONS.
 - ③ WEGO INSTALLED POSTS IN LANDSCAPING SHOULD BE PROPERLY SECURED IN THE GROUND AT A MINIMUM OF 30" INCHES BELOW GRADE AND ENCLOSED IN CONCRETE (REQUIRES AN 11-FOOT POST).
 - ④ WEGO POSTS SHOULD BE INSTALLED IN THE GRASS STRIP IN FRONT OF THE SIDEWALK OR BEHIND THE SIDEWALK, NOT IN THE SIDEWALK. IF SIDEWALK INSTALLATION IS NECESSARY, A 60 INCH (5 FOOT) MINIMUM CLEAR PATH MUST BE MAINTAINED ON THE SIDEWALK FROM THE EDGE OF THE SIGN PER NASHVILLE METRO PUBLIC WORKS GUIDELINES.
 - ⑤ BUS STOPS HAVE EITHER A BLUE BUS STOP SIGN OR A RAPID SERVICE SIGN. NO BUS STOP SHOULD HAVE BOTH. ALL SIGNS ARE TO BE IN THE FOLLOWING ORDER FROM TOP TO BOTTOM: BUS STOP SIGN OR RAPID SERVICE SIGN, SCHEMATIC SIGN, CIRCULATOR SIGN, ADOPT-A-STOP SIGN.
 - ⑥ PER ADA REQUIREMENTS, SIGNS MOUNTED ON POSTS OR PYLONS SHALL OVERHANG CIRCULATION PATHS 12 INCHES MAXIMUM WHEN LOCATED 27 INCHES MINIMUM AND 80 INCHES MAXIMUM ABOVE THE FINISH FLOOR OR GROUND.



WEGO PUBLIC TRANSIT
STANDARD BUS STOP DESIGN GUIDELINES

FLAG STOP

DRAWN BY: KYS
CHECKED BY:
DATE: SEPT 2018

REVISIONS	
BY:	DATE:

PROJECT NO.	SHEET NO.
	1

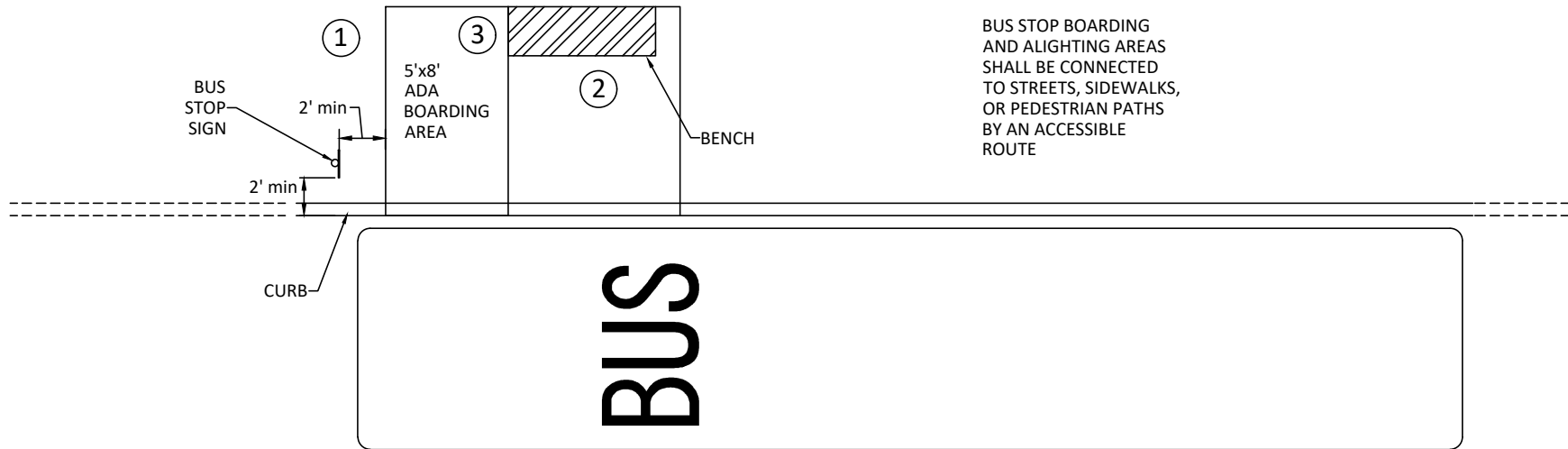

GENERAL NOTES	
(A)	FOR SPECIFIC CONDITIONS NOT COVERED ON THIS SHEET, REFERENCE SHOULD BE MADE TO THE DESIGN GUIDELINES REPORT.
(B)	DESIGN STANDARDS SHOWN IN THIS LAYOUT ARE REFERENCED FROM STATE OF TENNESSEE DEPARTMENT OF TRANSPORTATION AND NASHVILLE METRO PUBLIC WORKS STANDARD DRAWINGS, AS WELL AS 2010 ADA STANDARDS FOR ACCESSIBLE DESIGN. CURRENT STANDARDS SHOULD BE REVIEWED FOR COMPLIANCE BEFORE STOPS ARE INSTALLED OR MODIFIED.
(C)	DESIGN GUIDELINES SHOWN IN THIS LAYOUT ARE REFERENCED FROM NACTO'S 2016 TRANSIT STREET DESIGN GUIDE AND THE TRANSIT COOPERATIVE RESEARCH PROGRAM REPORT 19 - GUIDELINES FOR THE LOCATION AND DESIGN OF BUS STOPS. CURRENT DESIGN GUIDELINES SHOULD BE REVIEWED FOR COMPLIANCE BEFORE STOPS ARE INSTALLED OR MODIFIED.
(D)	ALL SIGNS, SYMBOLS, MARKINGS AND THEIR SPACING SHOULD ADHERE TO MUTCD, STATE AND LOCAL GUIDANCE.
(E)	TO PREVENT THE BUS STOP SIGNS FROM BEING STRUCK BY MIRRORS, ALL SIGNS SHOULD BE A MINIMUM OF 24 INCHES (2 FEET) FROM THE FACE OF THE CURB.
(F)	THE BUS STOP SIGN SHOULD BE LOCATED AT THE FRONT OF EACH BUS ZONE, TO LOCATE THE APPROXIMATE STOPPING POINT FOR THE FRONT OF THE BUS.
(G)	THE 5'X8' ADA BOARDING AREA SHOULD ALIGN WITH THE WHEELCHAIR LOADING POSITION OF ANY BUS IN MTA'S FLEET THAT WOULD TYPICALLY BE ASSIGNED TO THAT ROUTE.

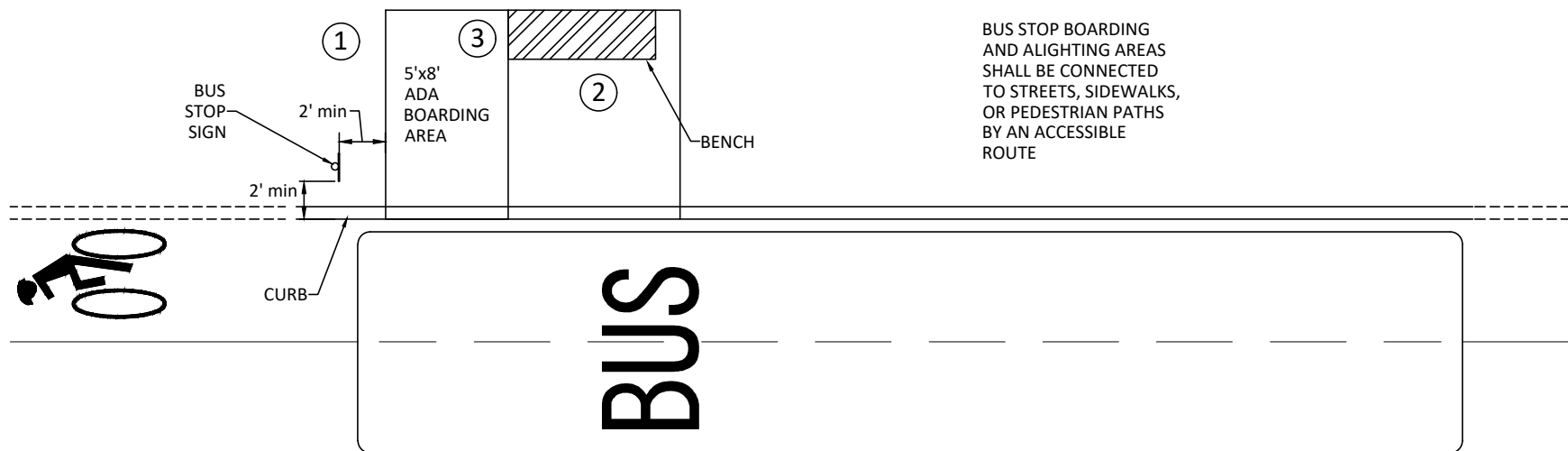

BENCH STOP NOTES	
(1)	REFER TO SHEET 1 FOR STANDARDS RELATED TO SIGN INSTALLATION.
(2)	A MINIMUM CLEARANCE OF 60 INCHES (5 FEET) SHALL BE MAINTAINED FOR A CLEAR PATH AROUND BUS STOP ELEMENTS PER METRO PUBLIC WORKS AND WEGO STANDARDS.
(3)	THE BENCH SHOULD BE INSTALLED ADJACENT TO (BUT NOT IMPEDING) THE ADA LANDING AREA AND CONNECTED TO A PEDESTRIAN PATHWAY.
(4)	BENCHES SHOULD BE LOCATED OUTSIDE OF A MINIMUM 10-FOOT RADIUS AROUND A NASHVILLE ELECTRIC SERVICE POLE FOR A FALL SAFE ZONE.
(5)	COORDINATE BENCH LOCATIONS WITH EXISTING STREET LIGHTS TO INCREASE VISIBILITY AND ENHANCE SECURITY AT A STOP.
(6)	LOCATE BENCHES AWAY FROM DRIVEWAYS TO ENHANCE PATRON SAFETY AND COMFORT.
(7)	COORDINATE BENCH LOCATIONS WITH EXISTING SHADE IF POSSIBLE TO AVOID DIRECT EXPOSURE TO HEAT AND SUN, WHICH CAN DISCOURAGE USE OF THE BENCH.



WEGO PUBLIC TRANSIT
STANDARD BUS STOP DESIGN GUIDELINES

BENCH STOP

DRAWN BY: KYS
CHECKED BY:
DATE: SEPT 2018

REVISIONS	
BY:	DATE:

PROJECT NO.	SHEET NO.
	2

© 2012 CDM SMITH ALL RIGHTS RESERVED. REUSE OF DOCUMENTS: THESE DOCUMENTS AND DESIGNS PROVIDED BY PROFESSIONAL SERVICE, INCORPORATED HEREIN, ARE THE PROPERTY OF CDM SMITH AND ARE NOT TO BE USED, IN WHOLE OR PART, FOR ANY OTHER PROJECT WITHOUT THE WRITTEN AUTHORIZATION OF CDM SMITH.

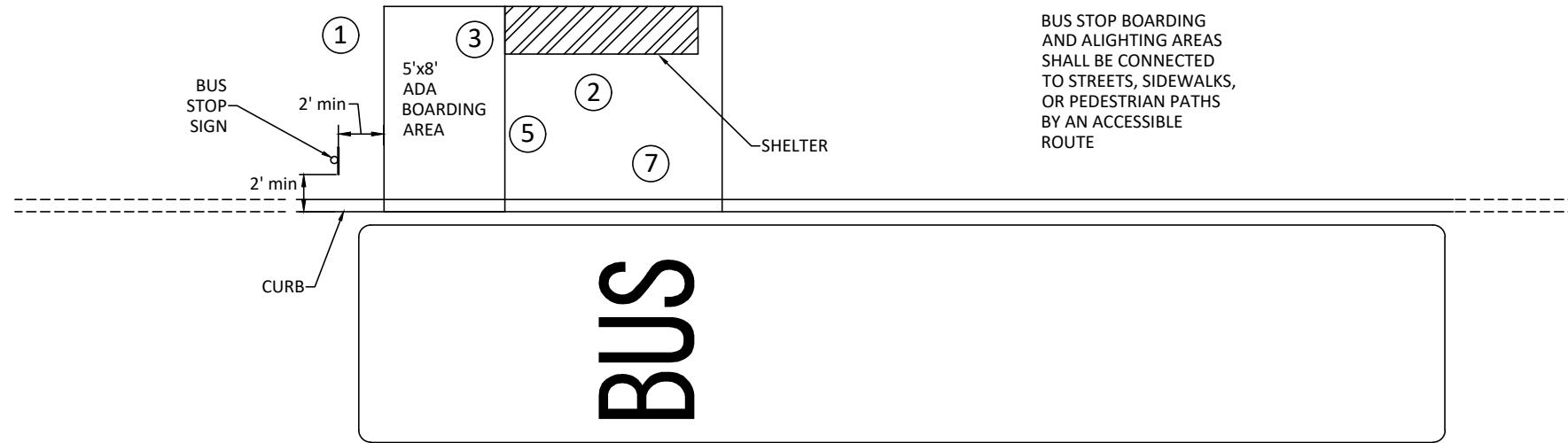

- GENERAL NOTES**
- (A) FOR SPECIFIC CONDITIONS NOT COVERED ON THIS SHEET, REFERENCE SHOULD BE MADE TO THE DESIGN GUIDELINES REPORT.
 - (B) DESIGN STANDARDS SHOWN IN THIS LAYOUT ARE REFERENCED FROM STATE OF TENNESSEE DEPARTMENT OF TRANSPORTATION AND NASHVILLE METRO PUBLIC WORKS STANDARD DRAWINGS, AS WELL AS 2010 ADA STANDARDS FOR ACCESSIBLE DESIGN. CURRENT STANDARDS SHOULD BE REVIEWED FOR COMPLIANCE BEFORE STOPS ARE INSTALLED OR MODIFIED.
 - (C) DESIGN GUIDELINES SHOWN IN THIS LAYOUT ARE REFERENCED FROM NACTO'S 2016 TRANSIT STREET DESIGN GUIDE AND THE TRANSIT COOPERATIVE RESEARCH PROGRAM REPORT 19 - GUIDELINES FOR THE LOCATION AND DESIGN OF BUS STOPS. CURRENT DESIGN GUIDELINES SHOULD BE REVIEWED FOR COMPLIANCE BEFORE STOPS ARE INSTALLED OR MODIFIED.
 - (D) ALL SIGNS, SYMBOLS, MARKINGS AND THEIR SPACING SHOULD ADHERE TO MUTCD, STATE AND LOCAL GUIDANCE.
 - (E) TO PREVENT THE BUS STOP SIGNS FROM BEING STRUCK BY MIRRORS, ALL SIGNS SHOULD BE A MINIMUM OF 24 INCHES (2 FEET) FROM THE FACE OF THE CURB.
 - (F) THE BUS STOP SIGN SHOULD BE LOCATED AT THE FRONT OF EACH BUS ZONE, TO LOCATE THE APPROXIMATE STOPPING POINT FOR THE FRONT OF THE BUS.
 - (G) THE 5'X8' ADA BOARDING AREA SHOULD ALIGN WITH THE WHEELCHAIR LOADING POSITION OF ANY BUS IN MTA'S FLEET THAT WOULD TYPICALLY BE ASSIGNED TO THAT ROUTE.

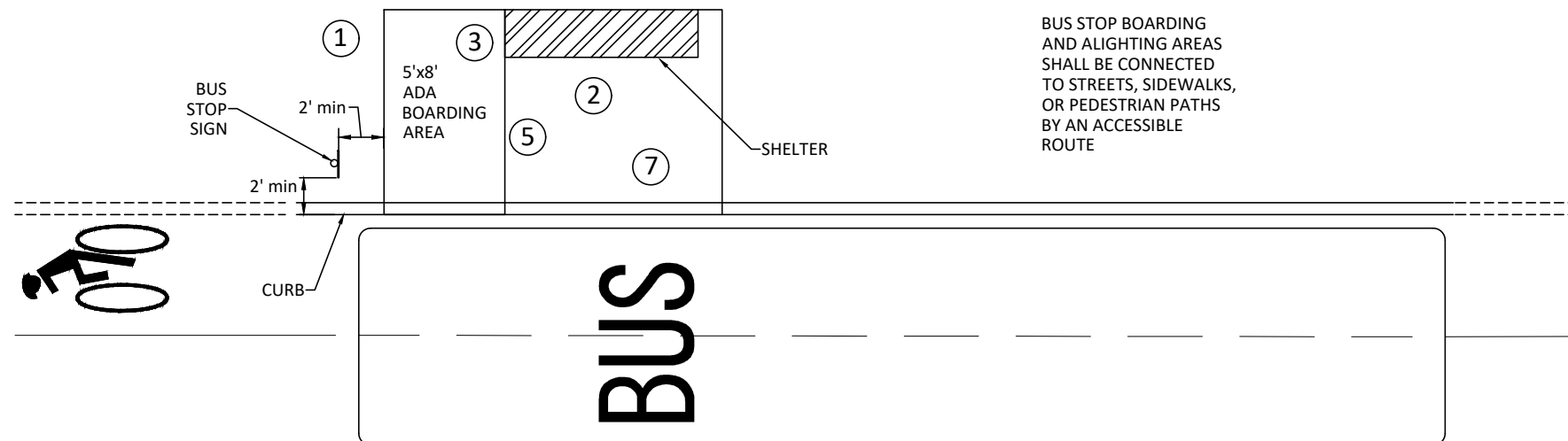

- SHELTER STOP NOTES**
- (1) REFER TO SHEET 1 FOR STANDARDS RELATED TO SIGN INSTALLATIONS.
 - (2) A MINIMUM CLEARANCE OF 60 INCHES (5 FEET) SHALL BE MAINTAINED FOR A CLEAR PATH AROUND BUS STOP ELEMENTS PER METRO PUBLIC WORKS AND WEGO STANDARDS.
 - (3) THE 60-INCH (5-FOOT) X 98-INCH (8-FOOT) ADA ACCESSIBLE LANDING PAD MAY BE LOCATED WITHIN OR OUTSIDE THE SHELTER.
 - (4) SHELTERS SHOULD BE LOCATED OUTSIDE OF A MINIMUM 10-FOOT RADIUS AROUND A NASHVILLE ELECTRIC SERVICE POLE FOR A FALL SAFE ZONE.
 - (5) SHELTERS MUST NOT BE MORE THAN 15 FEET FROM THE ADA LANDING PAD.
 - (6) SHELTERS MUST NOT BE LOCATED WITHIN 15 FEET OF A FIRE HYDRANT OR HANDICAP PARKING SPACE.
 - (7) A MINIMUM CLEARANCE OF 24 INCHES (2 FEET) BETWEEN THE SHELTER ROOF AND CURB FACE IS REQUIRED TO PREVENT IT FROM BEING STRUCK BY MIRRORS.



WEGO PUBLIC TRANSIT
STANDARD BUS STOP DESIGN GUIDELINES

SHELTER STOP

DRAWN BY: KYS
CHECKED BY:
DATE: SEPT 2018

REVISIONS	
BY:	DATE:

PROJECT NO.	SHEET NO.
	3

© 2012 CDM SMITH ALL RIGHTS RESERVED. REUSE OF DOCUMENTS: THESE DOCUMENTS AND DESIGNS PROVIDED BY PROFESSIONAL SERVICE, INCORPORATED HEREIN, ARE THE PROPERTY OF CDM SMITH AND ARE NOT TO BE USED, IN WHOLE OR PART, FOR ANY OTHER PROJECT WITHOUT THE WRITTEN AUTHORIZATION OF CDM SMITH.

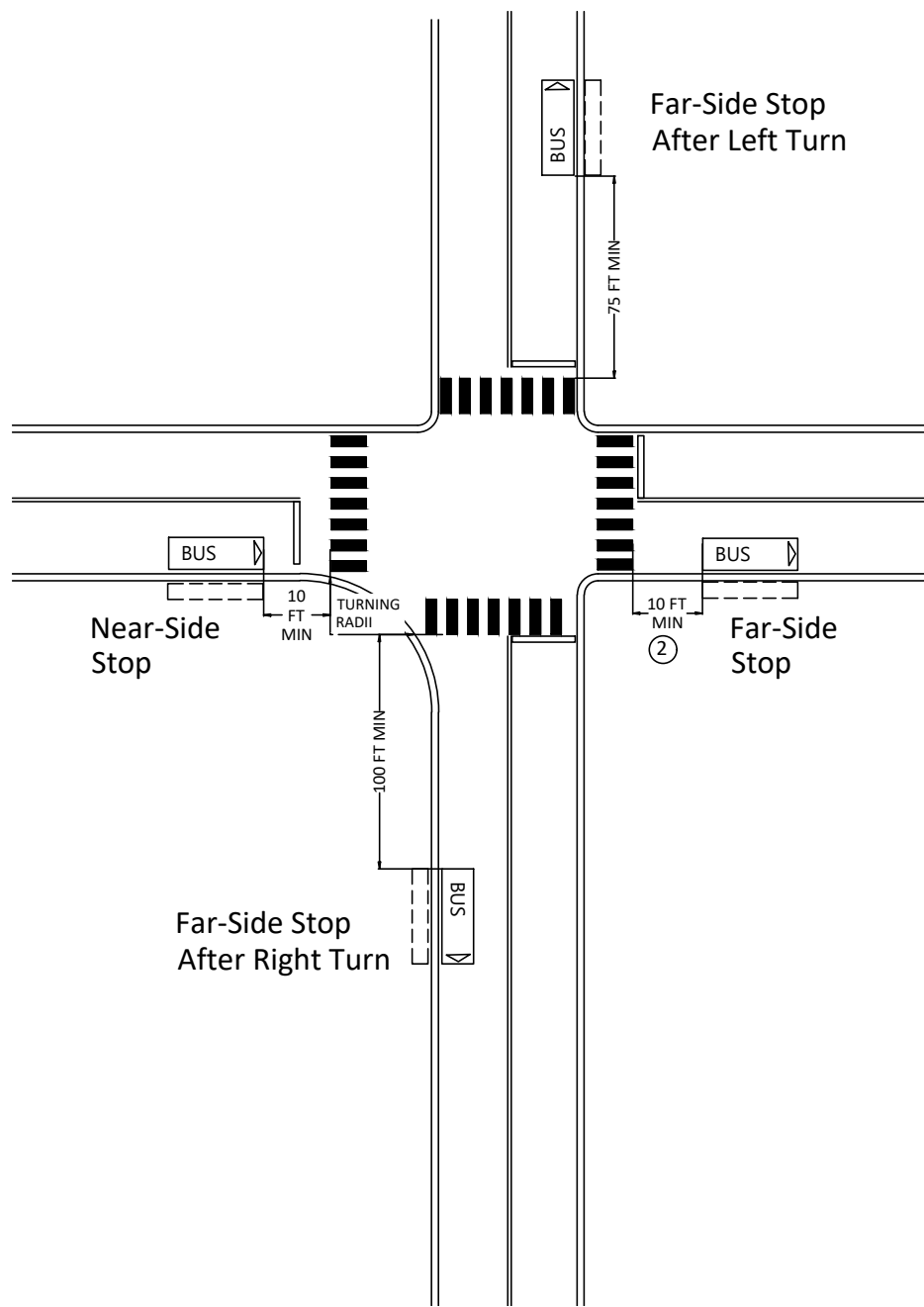

- GENERAL NOTES**
- (A) FOR SPECIFIC CONDITIONS NOT COVERED ON THIS SHEET, REFERENCE SHOULD BE MADE TO THE DESIGN GUIDELINES REPORT.
 - (B) DESIGN STANDARDS SHOWN IN THIS LAYOUT ARE REFERENCED FROM STATE OF TENNESSEE DEPARTMENT OF TRANSPORTATION AND NASHVILLE METRO PUBLIC WORKS STANDARD DRAWINGS, AS WELL AS 2010 ADA STANDARDS FOR ACCESSIBLE DESIGN. CURRENT STANDARDS SHOULD BE REVIEWED FOR COMPLIANCE BEFORE STOPS ARE INSTALLED OR MODIFIED.
 - (C) DESIGN GUIDELINES SHOWN IN THIS LAYOUT ARE REFERENCED FROM NACTO'S 2016 TRANSIT STREET DESIGN GUIDE AND THE TRANSIT COOPERATIVE RESEARCH PROGRAM REPORT 19 - GUIDELINES FOR THE LOCATION AND DESIGN OF BUS STOPS. CURRENT DESIGN GUIDELINES SHOULD BE REVIEWED FOR COMPLIANCE BEFORE STOPS ARE INSTALLED OR MODIFIED.
 - (D) ALL SIGNS, SYMBOLS, MARKINGS AND THEIR SPACING SHOULD ADHERE TO MUTCD, STATE AND LOCAL GUIDANCE.
 - (E) TO PREVENT THE BUS STOP SIGNS FROM BEING STRUCK BY MIRRORS, ALL SIGNS SHOULD BE A MINIMUM OF 24 INCHES (2 FEET) FROM THE FACE OF THE CURB.
 - (F) THE BUS STOP SIGN SHOULD BE LOCATED AT THE FRONT OF EACH BUS ZONE, TO LOCATE THE APPROXIMATE STOPPING POINT FOR THE FRONT OF THE BUS.
 - (G) THE 5'x8' ADA BOARDING AREA SHOULD ALIGN WITH THE WHEELCHAIR LOADING POSITION OF ANY BUS IN MTA'S FLEET THAT WOULD TYPICALLY BE ASSIGNED TO THAT ROUTE.

- FOOTNOTES**
- ① REFER TO SHEETS 1 AND 3 FOR SIGN AND SHELTER STANDARDS.
 - ② PROVIDE AT LEAST 10 FEET OF CLEAR DISTANCE FROM CROSSWALK OR CURB RETURN TO THE BUS. THE LENGTH MAY BE LONGER ON HIGH VOLUME AREAS TO ALLOW QUEUING ON FAR-SIDE STOPS.
 - ③ SEE TABLE I FOR BUS PLATFORM LENGTH.
 - ④ A MINIMUM CLEARANCE OF 60 INCHES (5 FEET) SHALL BE MAINTAINED FOR A CLEAR PATH AROUND BUS STOP ELEMENTS PER METRO PUBLIC WORKS AND WEGO STANDARDS.

TABLE I : DESIRED MINIMUM PLATFORM LENGTH

STOP POSITION	40' BUS	60' BUS	2x40' BUS	2x60' BUS
NEAR-SIDE	35	55	80	115
FAR-SIDE	45	65	90	130
MID-BLOCK	35	55	80	115

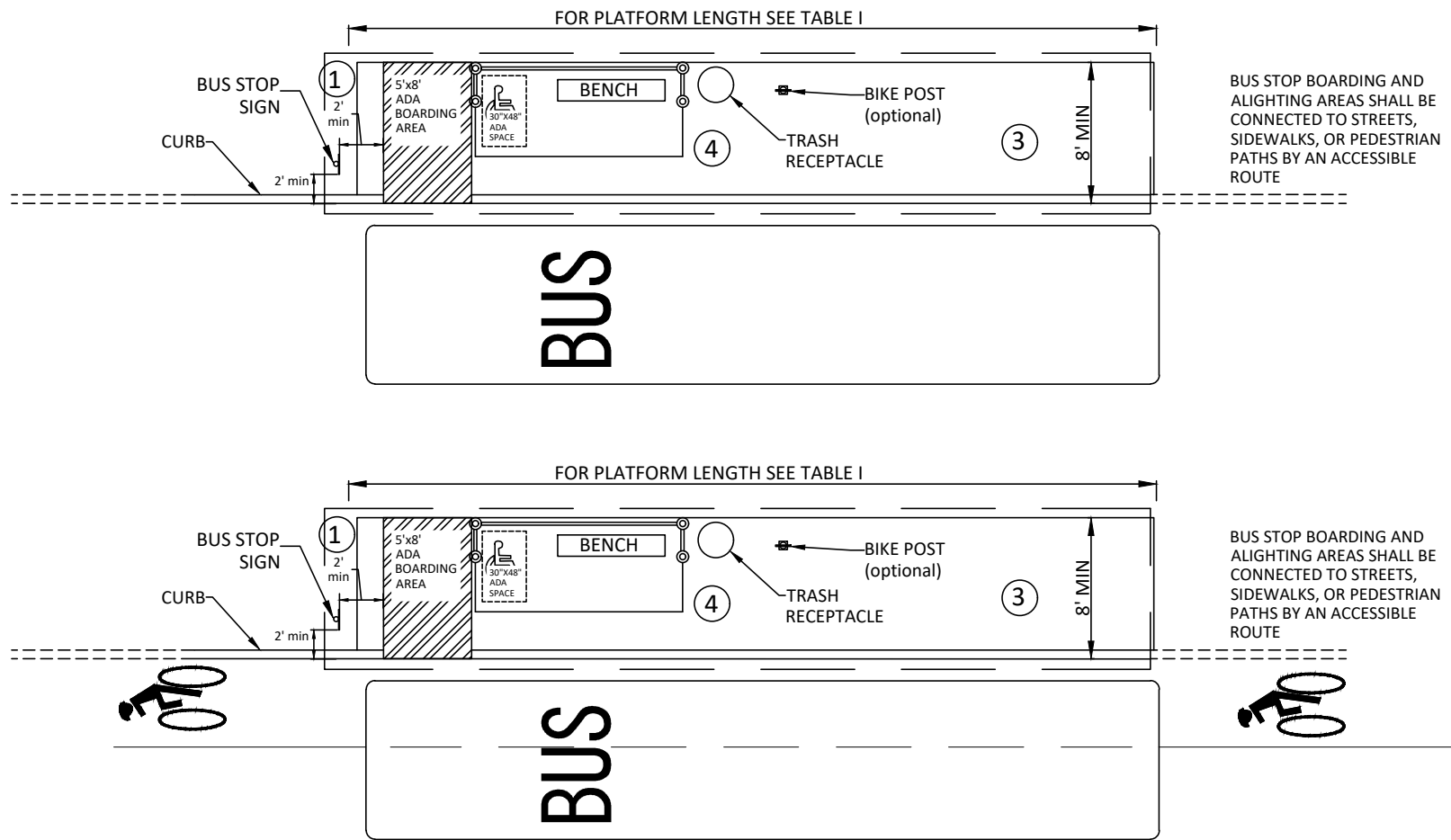

WEGO PUBLIC TRANSIT
STANDARD BUS STOP DESIGN GUIDELINES

IN-LANE CURBSIDE STOP

DRAWN BY: KYS

CHECKED BY:

DATE SEPT 2018

REVISIONS

BY: DATE:

PROJECT NO.

SHEET NO.

4

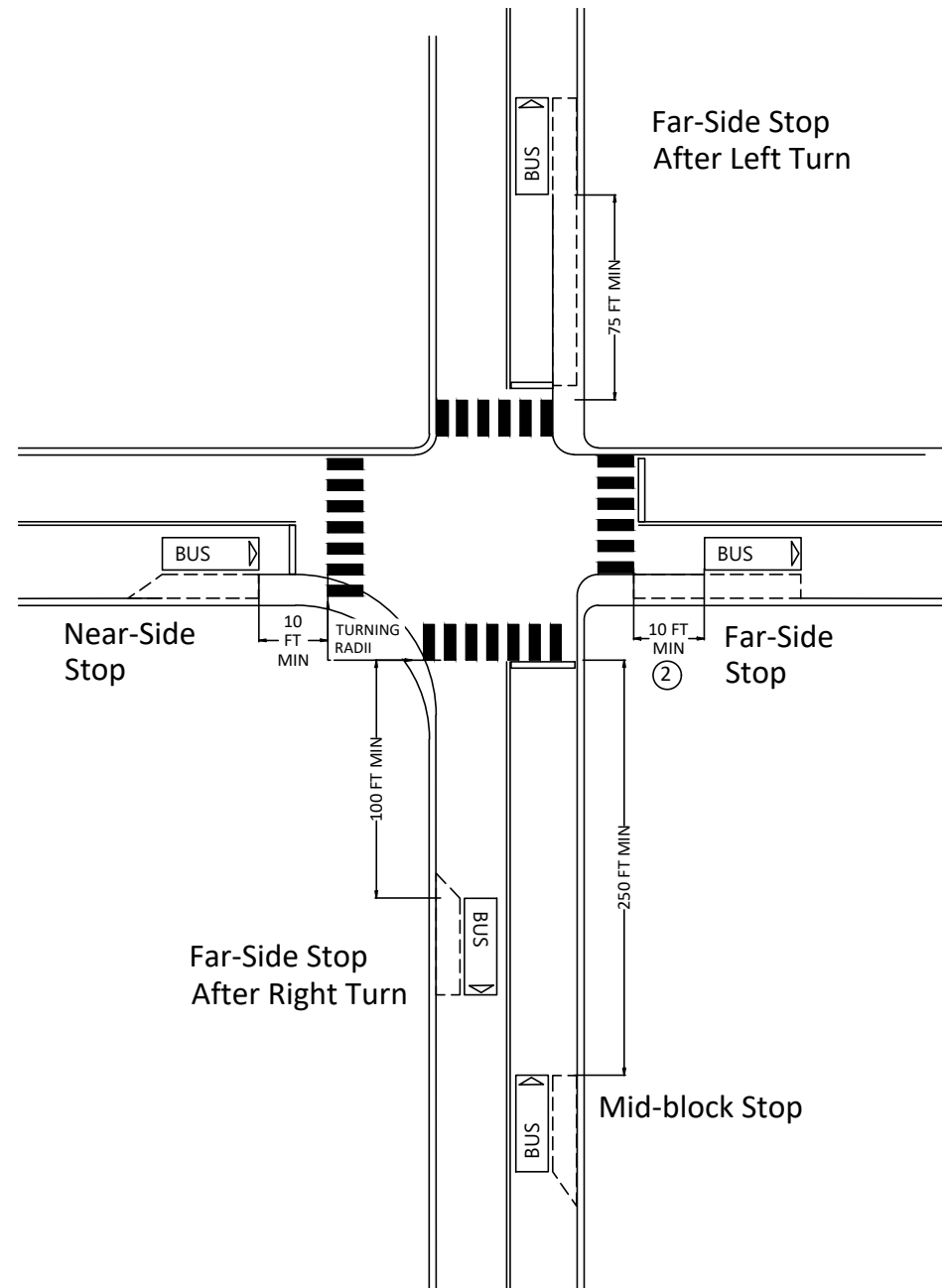

- GENERAL NOTES**
- (A) FOR SPECIFIC CONDITIONS NOT COVERED ON THIS SHEET, REFERENCE SHOULD BE MADE TO THE DESIGN GUIDELINES REPORT.
 - (B) DESIGN STANDARDS SHOWN IN THIS LAYOUT ARE REFERENCED FROM STATE OF TENNESSEE DEPARTMENT OF TRANSPORTATION AND NASHVILLE METRO PUBLIC WORKS STANDARD DRAWINGS, AS WELL AS 2010 ADA STANDARDS FOR ACCESSIBLE DESIGN. CURRENT STANDARDS SHOULD BE REVIEWED FOR COMPLIANCE BEFORE STOPS ARE INSTALLED OR MODIFIED.
 - (C) DESIGN GUIDELINES SHOWN IN THIS LAYOUT ARE REFERENCED FROM NACTO'S 2016 TRANSIT STREET DESIGN GUIDE AND THE TRANSIT COOPERATIVE RESEARCH PROGRAM REPORT 19 - GUIDELINES FOR THE LOCATION AND DESIGN OF BUS STOPS. CURRENT DESIGN GUIDELINES SHOULD BE REVIEWED FOR COMPLIANCE BEFORE STOPS ARE INSTALLED OR MODIFIED.
 - (D) ALL SIGNS, SYMBOLS, MARKINGS AND THEIR SPACING SHOULD ADHERE TO MUTCD, STATE AND LOCAL GUIDANCE.
 - (E) TO PREVENT THE BUS STOP SIGNS FROM BEING STRUCK BY MIRRORS, ALL SIGNS SHOULD BE A MINIMUM OF 24 INCHES (2 FEET) FROM THE FACE OF THE CURB.
 - (F) THE BUS STOP SIGN SHOULD BE LOCATED AT THE FRONT OF EACH BUS ZONE, TO LOCATE THE APPROXIMATE STOPPING POINT FOR THE FRONT OF THE BUS.
 - (G) THE 5'X8' ADA BOARDING AREA SHOULD ALIGN WITH THE WHEELCHAIR LOADING POSITION OF ANY BUS IN MTA'S FLEET THAT WOULD TYPICALLY BE ASSIGNED TO THAT ROUTE.

- FOOTNOTES**
- ① REFER TO SHEETS 1 AND 3 FOR SIGN AND SHELTER STANDARDS .
 - ② PROVIDE AT LEAST 10 FEET OF CLEAR DISTANCE FROM CROSSWALK OR CURB RETURN TO THE BUS. THE LENGTH MAY BE LONGER ON HIGH VOLUME AREAS TO ALLOW QUEUING ON FAR-SIDE STOPS.
 - ③ SEE TABLE I FOR BUS PLATFORM LENGTH.
 - ④ A MINIMUM CLEARANCE OF 60 INCHES (5 FEET) SHALL BE MAINTAINED FOR A CLEAR PATH AROUND BUS STOP ELEMENTS PER METRO PUBLIC WORKS AND WEGO STANDARDS.
 - ⑤ BUS BULB SHOULD BE ROUGHLY THE WIDTH OF THE PARKING LANE AND HAVE A 45 DEGREE RETURN ANGLE AT THE PARKING END.

TABLE I : DESIRED MINIMUM PLATFORM LENGTH

STOP POSITION	40' BUS	60' BUS	2x40' BUS	2x60' BUS
NEAR-SIDE	35	55	80	115
FAR-SIDE	45	65	90	130
MID-BLOCK	35	55	80	115

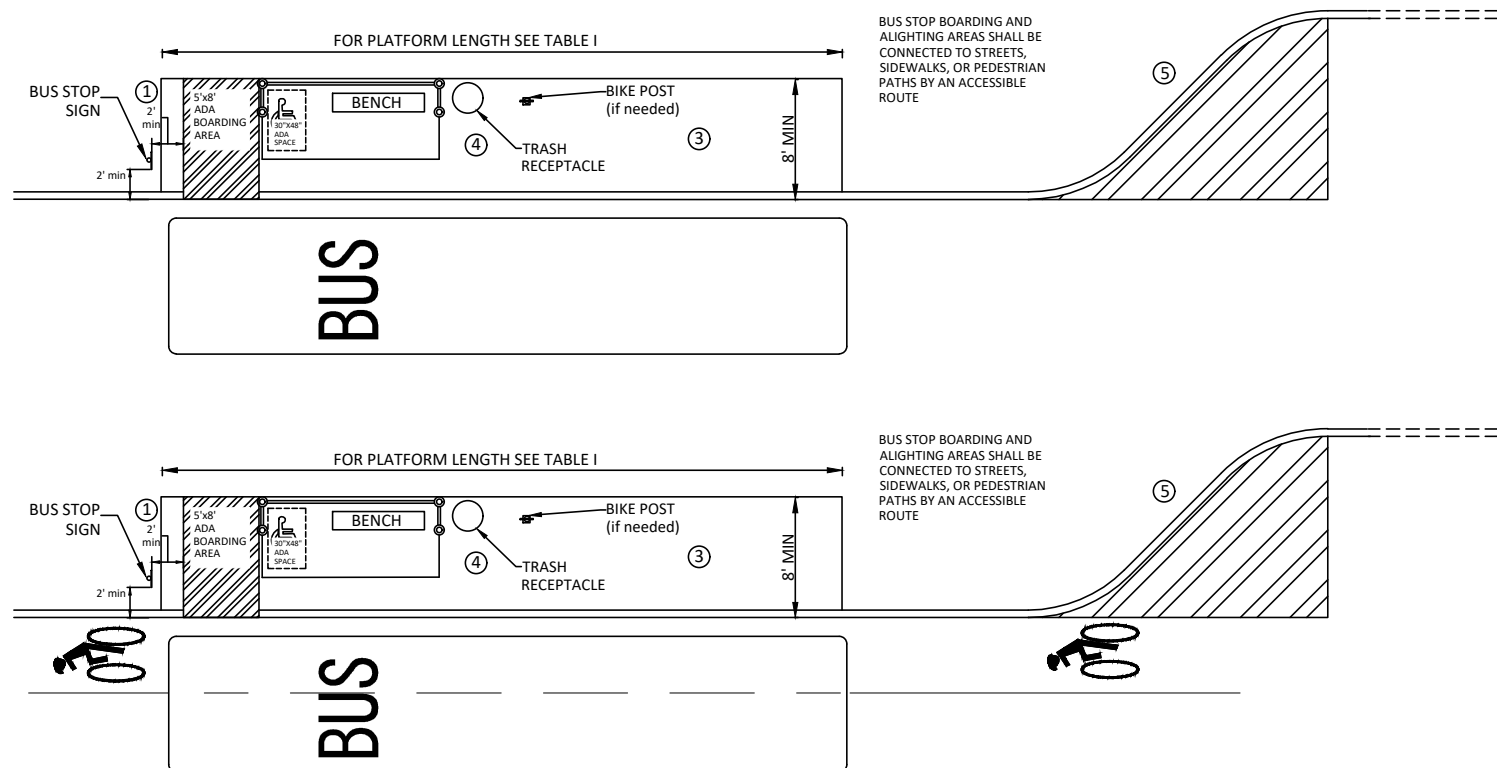

WEGO PUBLIC TRANSIT
STANDARD BUS STOP DESIGN GUIDELINES

BUS BULB STOP

DRAWN BY: KYS

CHECKED BY:

DATE SEPT 2018

REVISIONS

BY: DATE:

PROJECT NO.

SHEET NO.

5

© 2012 CDM SMITH. ALL RIGHTS RESERVED. REUSE OF DOCUMENTS: THESE DOCUMENTS AND DESIGNS PROVIDED BY PROFESSIONAL SERVICE, INCORPORATED HEREIN, ARE THE PROPERTY OF CDM SMITH AND ARE NOT TO BE USED, IN WHOLE OR PART, FOR ANY OTHER PROJECT WITHOUT THE WRITTEN AUTHORIZATION OF CDM SMITH.

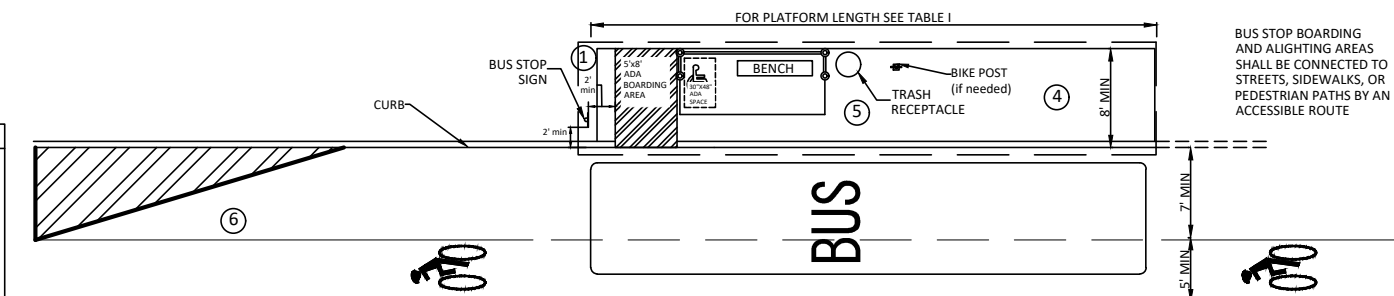
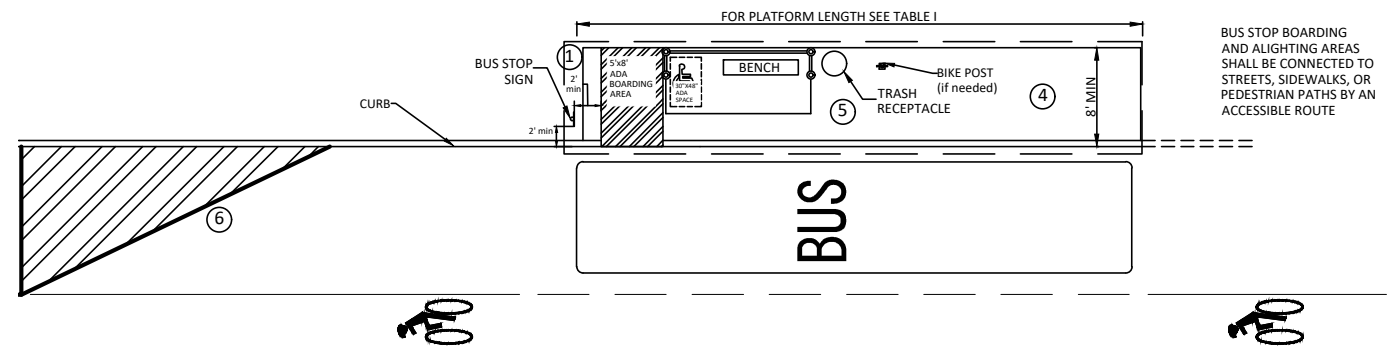
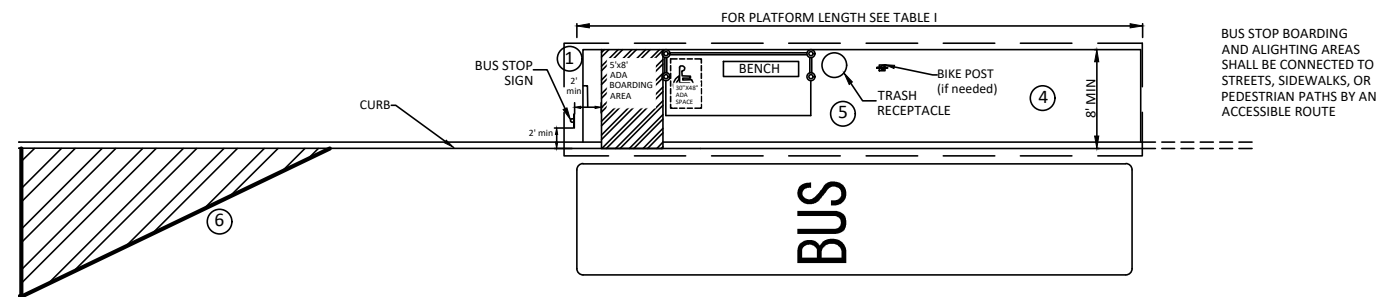
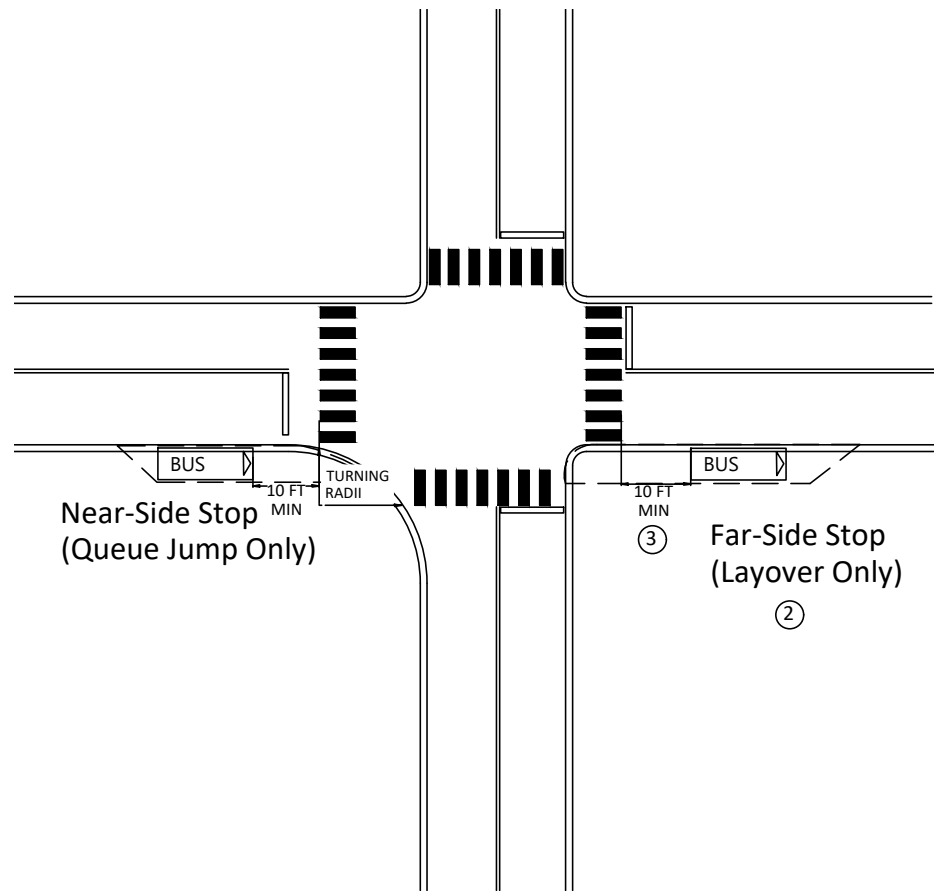

- GENERAL NOTES**
- (A) FOR SPECIFIC CONDITIONS NOT COVERED ON THIS SHEET, REFERENCE SHOULD BE MADE TO THE DESIGN GUIDELINES REPORT.
 - (B) DESIGN STANDARDS SHOWN IN THIS LAYOUT ARE REFERENCED FROM STATE OF TENNESSEE DEPARTMENT OF TRANSPORTATION AND NASHVILLE METRO PUBLIC WORKS STANDARD DRAWINGS, AS WELL AS 2010 ADA STANDARDS FOR ACCESSIBLE DESIGN. CURRENT STANDARDS SHOULD BE REVIEWED FOR COMPLIANCE BEFORE STOPS ARE INSTALLED OR MODIFIED.
 - (C) DESIGN GUIDELINES SHOWN IN THIS LAYOUT ARE REFERENCED FROM NACTO'S 2016 TRANSIT STREET DESIGN GUIDE AND THE TRANSIT COOPERATIVE RESEARCH PROGRAM REPORT 19 - GUIDELINES FOR THE LOCATION AND DESIGN OF BUS STOPS. CURRENT DESIGN GUIDELINES SHOULD BE REVIEWED FOR COMPLIANCE BEFORE STOPS ARE INSTALLED OR MODIFIED.
 - (D) ALL SIGNS, SYMBOLS, MARKINGS AND THEIR SPACING SHOULD ADHERE TO MUTCD, STATE AND LOCAL GUIDANCE.
 - (E) TO PREVENT THE BUS STOP SIGNS FROM BEING STRUCK BY MIRRORS, ALL SIGNS SHOULD BE A MINIMUM OF 24 INCHES (2 FEET) FROM THE FACE OF THE CURB.
 - (F) THE BUS STOP SIGN SHOULD BE LOCATED AT THE FRONT OF EACH BUS ZONE, TO LOCATE THE APPROXIMATE STOPPING POINT FOR THE FRONT OF THE BUS.
 - (G) THE 5'X8' ADA BOARDING AREA SHOULD ALIGN WITH THE WHEELCHAIR LOADING POSITION OF ANY BUS IN MTA'S FLEET THAT WOULD TYPICALLY BE ASSIGNED TO THAT ROUTE.

TABLE I : DESIRED MINIMUM PLATFORM LENGTH

STOP POSITION	40' BUS	60' BUS	2x40' BUS	2x60' BUS
NEAR-SIDE	35	55	80	115
FAR-SIDE	45	65	90	130
MID-BLOCK	35	55	80	115

- FOOTNOTES**
- ① REFER TO SHEETS 1 AND 3 FOR SIGN AND SHELTER STANDARDS .
 - ② PULLOUT STOPS SHOULD ONLY BE UTILIZED AT NEARSIDE QUEUE JUMP OR FAR SIDE LAYOVER STOPS ONLY.
 - ③ PROVIDE AT LEAST 10 FEET OF CLEAR DISTANCE FROM CROSSWALK OR CURB RETURN TO THE BUS. THE LENGTH MAY BE LONGER ON HIGH VOLUME AREAS TO ALLOW QUEUING ON FAR-SIDE STOPS.
 - ④ SEE TABLE I FOR BUS PLATFORM LENGTH.
 - ⑤ A MINIMUM CLEARANCE OF 60 INCHES (5 FEET) SHALL BE MAINTAINED FOR A CLEAR PATH AROUND BUS STOP ELEMENTS PER METRO PUBLIC WORKS AND MTA STANDARDS.
 - ⑥ EXIT TAPER IS TYPICALLY 25-30 FEET. ENFORCEMENT SHOULD ENSURE STOP AREAS REMAIN UNBLOCKED BY PARKING OR LOADING.



WEGO PUBLIC TRANSIT
STANDARD BUS STOP DESIGN GUIDELINES

BUS PULLOUT STOP

DRAWN BY: KYS
CHECKED BY:
DATE SEPT 2018

REVISIONS	
BY:	DATE:

PROJECT NO.
SHEET NO.

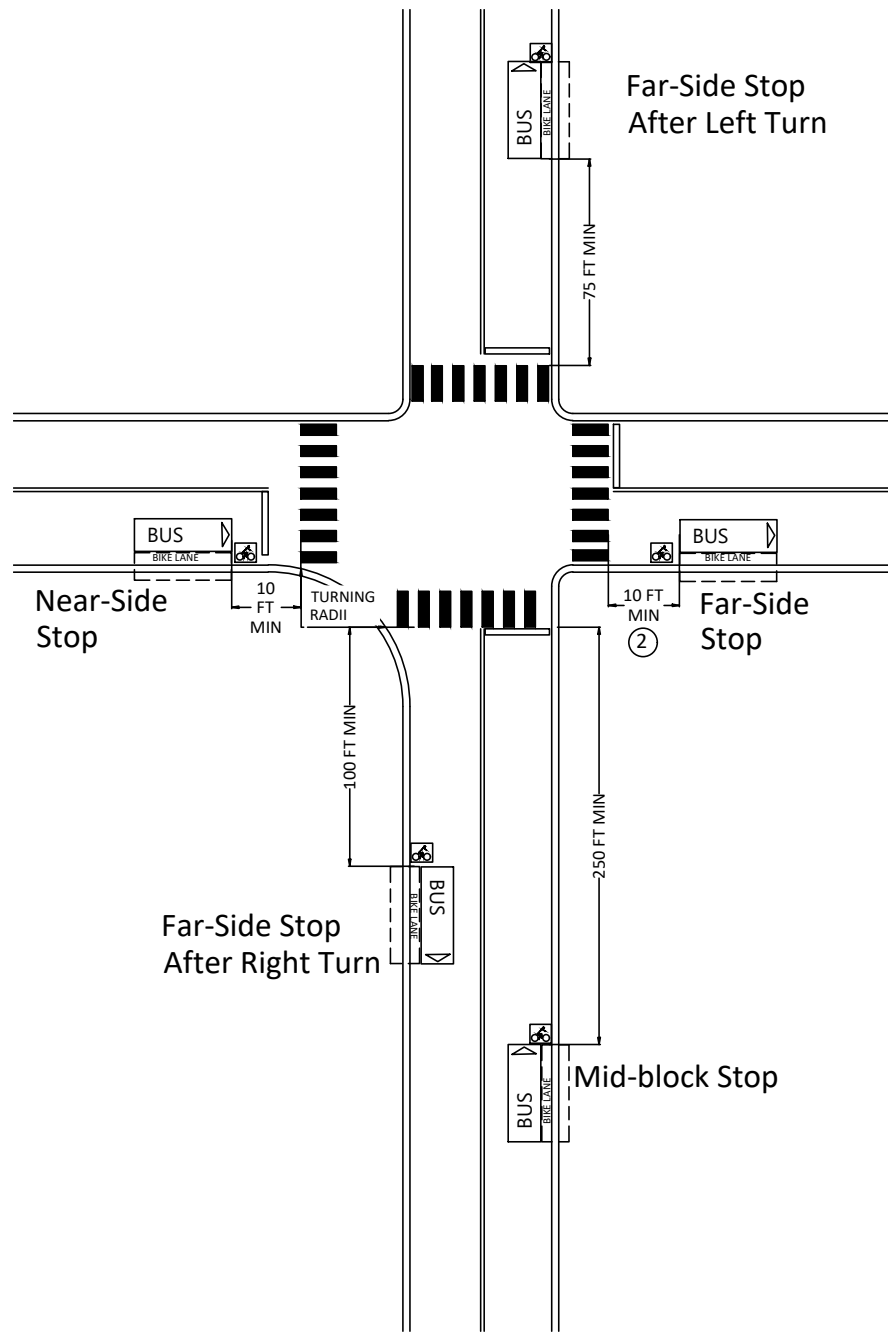

- GENERAL NOTES**
- (A) FOR SPECIFIC CONDITIONS NOT COVERED ON THIS SHEET, REFERENCE SHOULD BE MADE TO THE DESIGN GUIDELINES REPORT.
 - (B) DESIGN STANDARDS SHOWN IN THIS LAYOUT ARE REFERENCED FROM STATE OF TENNESSEE DEPARTMENT OF TRANSPORTATION AND NASHVILLE METRO PUBLIC WORKS STANDARD DRAWINGS, AS WELL AS 2010 ADA STANDARDS FOR ACCESSIBLE DESIGN. CURRENT STANDARDS SHOULD BE REVIEWED FOR COMPLIANCE BEFORE STOPS ARE INSTALLED OR MODIFIED.
 - (C) DESIGN GUIDELINES SHOWN IN THIS LAYOUT ARE REFERENCED FROM NACTO'S 2016 TRANSIT STREET DESIGN GUIDE AND THE TRANSIT COOPERATIVE RESEARCH PROGRAM REPORT 19 - GUIDELINES FOR THE LOCATION AND DESIGN OF BUS STOPS. CURRENT DESIGN GUIDELINES SHOULD BE REVIEWED FOR COMPLIANCE BEFORE STOPS ARE INSTALLED OR MODIFIED.
 - (D) ALL SIGNS, SYMBOLS, MARKINGS AND THEIR SPACING SHOULD ADHERE TO MUTCD, STATE AND LOCAL GUIDANCE.
 - (E) TO PREVENT THE BUS STOP SIGNS FROM BEING STRUCK BY MIRRORS, ALL SIGNS SHOULD BE A MINIMUM OF 24 INCHES (2 FEET) FROM THE FACE OF THE CURB.
 - (F) THE BUS STOP SIGN SHOULD BE LOCATED AT THE FRONT OF EACH BUS ZONE, TO LOCATE THE APPROXIMATE STOPPING POINT FOR THE FRONT OF THE BUS.
 - (G) THE 5'X8' ADA BOARDING AREA SHOULD ALIGN WITH THE WHEELCHAIR LOADING POSITION OF ANY BUS IN MTA'S FLEET THAT WOULD TYPICALLY BE ASSIGNED TO THAT ROUTE.

TABLE I : DESIRED MINIMUM PLATFORM LENGTH

STOP POSITION	40' BUS	60' BUS	2x40' BUS	2x60' BUS
NEAR-SIDE	35	55	80	115
FAR-SIDE	45	65	90	130
MID-BLOCK	35	55	80	115

- FOOTNOTES**
- ① REFER TO SHEETS 1 AND 3 FOR SIGN AND SHELTER STANDARDS .
 - ② THE BIKE LANE SHOULD BE COLORED ONLY ON THE RAMPS AND IN SECTIONS LEADING UP TO THE RAMP, INDICATING THAT THE LOADING AREA IS NOT RESERVED FOR BICYCLES.
 - ③ CROSSWALKS SHOULD NOT BE USED ACROSS THE PATHWAY OF THE BICYCLE, BUT SIGNING AND PAVEMENT MARKINGS SHOULD BE USED TO INDICATE THAT BICYCLISTS ARE TO YIELD TO PEDESTRIANS WITHIN THE LOADING AREA.
 - ④ DETECTABLE WARNING STRIPS SHOULD EXTEND PERPENDICULAR TO THE SIDEWALK AT BOTH ENDS OF THE BICYCLE RAMP (FROM THE TOP OF THE BICYCLE RAMP INTO THE SIDEWALK) TO DEMARCATATE THE SHARED SPACE FOR THE VISUALLY IMPAIRED AND WARN AGAINST TRAVELING DOWN THE RAMP.

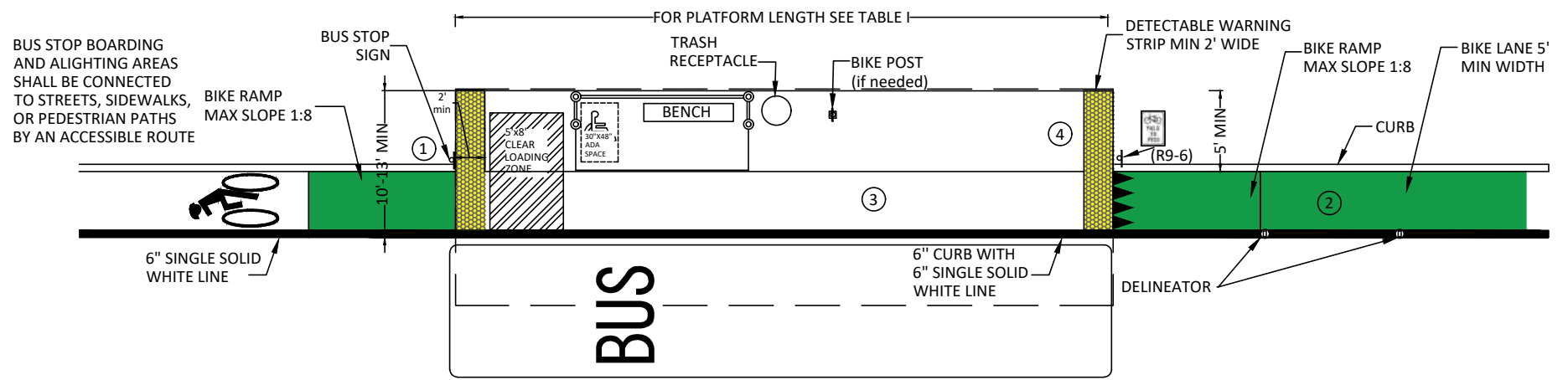
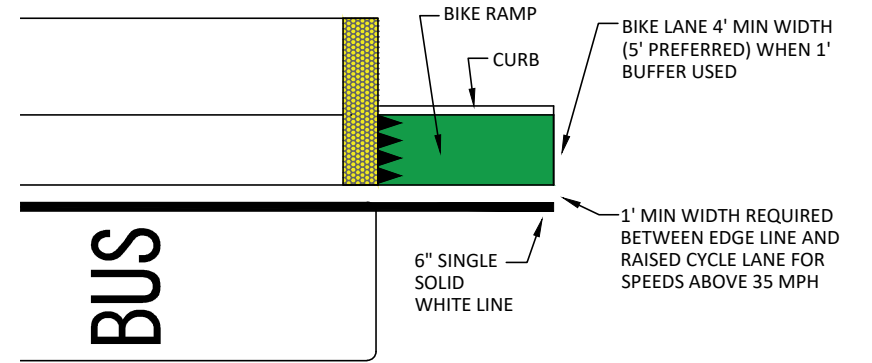

WEGO PUBLIC TRANSIT
STANDARD BUS STOP DESIGN GUIDELINES

SHARED CYCLE LANE STOP

DRAWN BY: KYS
CHECKED BY:
DATE SEPT 2018

REVISIONS	
BY:	DATE:

PROJECT NO.	SHEET NO.
	7

© 2012 CDM SMITH ALL RIGHTS RESERVED. REUSE OF DOCUMENTS, THESE DOCUMENTS AND DESIGNS PROVIDED BY PROFESSIONAL SERVICE, INCORPORATED HEREIN, ARE THE PROPERTY OF CDM SMITH AND ARE NOT TO BE USED, IN WHOLE OR PART, FOR ANY OTHER PROJECT WITHOUT THE WRITTEN AUTHORIZATION OF CDM SMITH.

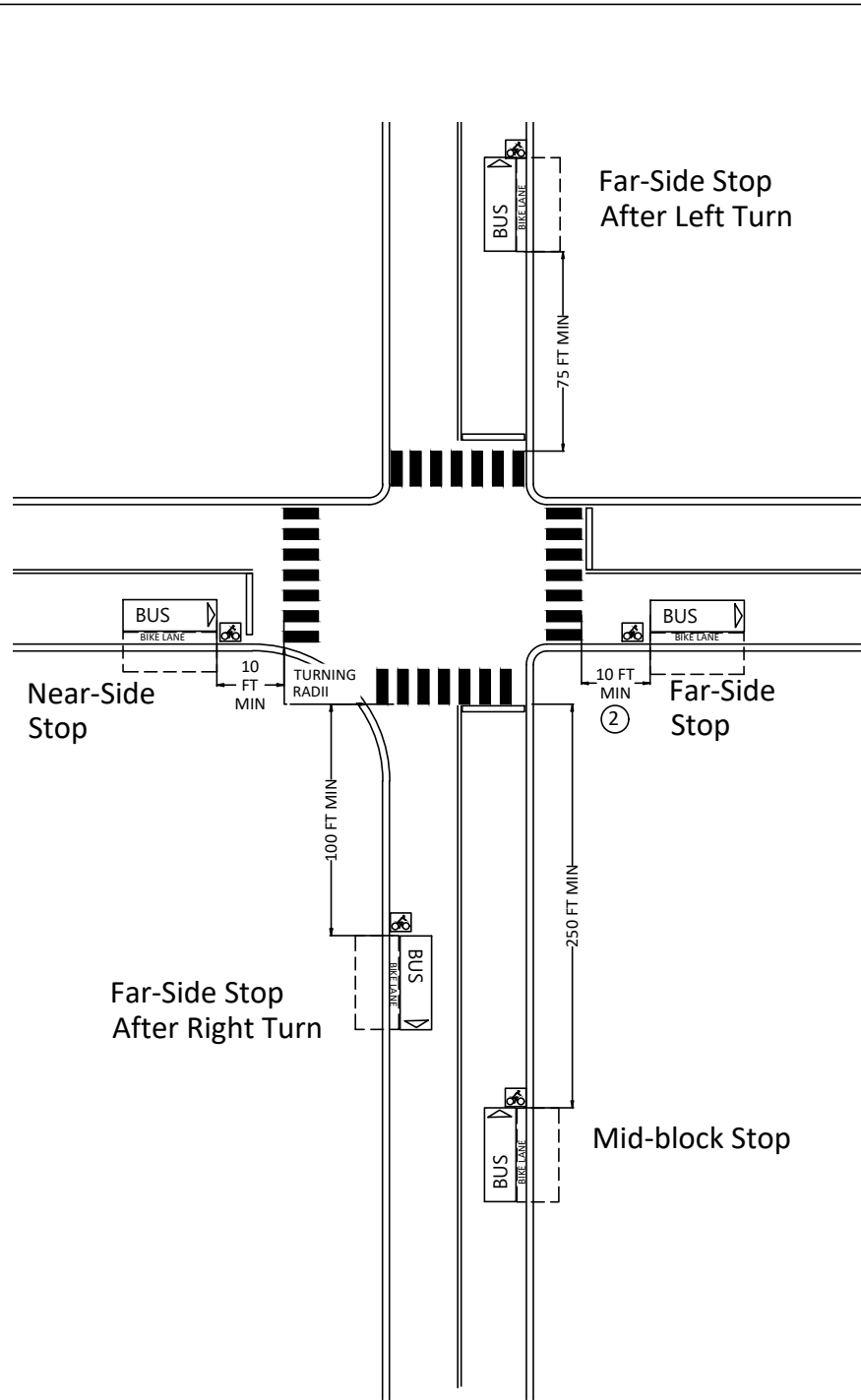

- GENERAL NOTES**
- (A) FOR SPECIFIC CONDITIONS NOT COVERED ON THIS SHEET, REFERENCE SHOULD BE MADE TO THE DESIGN GUIDELINES REPORT.
 - (B) DESIGN STANDARDS SHOWN IN THIS LAYOUT ARE REFERENCED FROM STATE OF TENNESSEE DEPARTMENT OF TRANSPORTATION AND NASHVILLE METRO PUBLIC WORKS STANDARD DRAWINGS, AS WELL AS 2010 ADA STANDARDS FOR ACCESSIBLE DESIGN. CURRENT STANDARDS SHOULD BE REVIEWED FOR COMPLIANCE BEFORE STOPS ARE INSTALLED OR MODIFIED.
 - (C) DESIGN GUIDELINES SHOWN IN THIS LAYOUT ARE REFERENCED FROM NACTO'S 2016 TRANSIT STREET DESIGN GUIDE AND THE TRANSIT COOPERATIVE RESEARCH PROGRAM REPORT 19 - GUIDELINES FOR THE LOCATION AND DESIGN OF BUS STOPS. CURRENT DESIGN GUIDELINES SHOULD BE REVIEWED FOR COMPLIANCE BEFORE STOPS ARE INSTALLED OR MODIFIED.
 - (D) ALL SIGNS, SYMBOLS, MARKINGS AND THEIR SPACING SHOULD ADHERE TO MUTCD, STATE AND LOCAL GUIDANCE.
 - (E) TO PREVENT THE BUS STOP SIGNS FROM BEING STRUCK BY MIRRORS, ALL SIGNS SHOULD BE A MINIMUM OF 24 INCHES (2 FEET) FROM THE FACE OF THE CURB.
 - (F) THE BUS STOP SIGN SHOULD BE LOCATED AT THE FRONT OF EACH BUS ZONE, TO LOCATE THE APPROXIMATE STOPPING POINT FOR THE FRONT OF THE BUS.
 - (G) THE 5'X8' ADA BOARDING AREA SHOULD ALIGN WITH THE WHEELCHAIR LOADING POSITION OF ANY BUS IN MTA'S FLEET THAT WOULD TYPICALLY BE ASSIGNED TO THAT ROUTE.

TABLE I : DESIRED MINIMUM PLATFORM LENGTH

STOP POSITION	40' BUS	60' BUS	2x40' BUS	2x60' BUS
NEAR-SIDE	35	55	80	115
FAR-SIDE	45	65	90	130
MID-BLOCK	35	55	80	115

- FOOTNOTES**
- (1) REFER TO SHEETS 1 AND 3 FOR SIGN AND SHELTER STANDARDS .
 - (2) PAVEMENT COLORING SHOULD BE UTILIZED FOR THE BICYCLE LANE FOR THE WIDTH OF THE STOP, INDICATING THAT THE LANE IS NOT INTENDED TO BE SHARED WHILE ALSO PROVIDING VISUAL INDICATION OF THE SEPARATE PATHS AND BETTER CONTRAST FOR PAVEMENT MARKINGS.
 - (3) CROSSWALKS SHOULD BE USED IN CONJUNCTION WITH SIGNING AND PAVEMENT MARKING TO INDICATE THE LOADING ZONES AND THAT BICYCLISTS ARE TO YIELD TO PEDESTRIANS WITHIN THE LOADING AREA.
 - (4) DETECTABLE WARNING STRIPS SHOULD BE APPLIED FOR THE WIDTH OF THE FLUSH TRANSITION BETWEEN THE SIDEWALK AND BICYCLE LANE TO DEMARCATATE THE TWO PATHS AND PROVIDE TACTILE CUES TO VISUALLY DISABLED PASSENGERS.
 - (5) DETECTABLE WARNING STRIPS SHOULD BE APPLIED IN THE BICYCLE LANE AT THE TOP OF THE RAMP AND PERPENDICULAR TO THE SIDEWALK TO WARN VISUALLY IMPAIRED PASSENGERS AGAINST TRAVELING DOWN THE RAMP.
 - (6) SHELTERS MAY BE REVERSED AND PLACED AT THE THRESHOLD OF THE SIDEWALK AND BICYCLE LANE IN LINE WITH THE DETECTABLE WARNING STRIPS TO INCREASE THE AVAILABLE CLEAR PATH AND FURTHER EMPHASIZE THE SEPARATION BETWEEN THE SIDEWALK AND BICYCLE LANE.

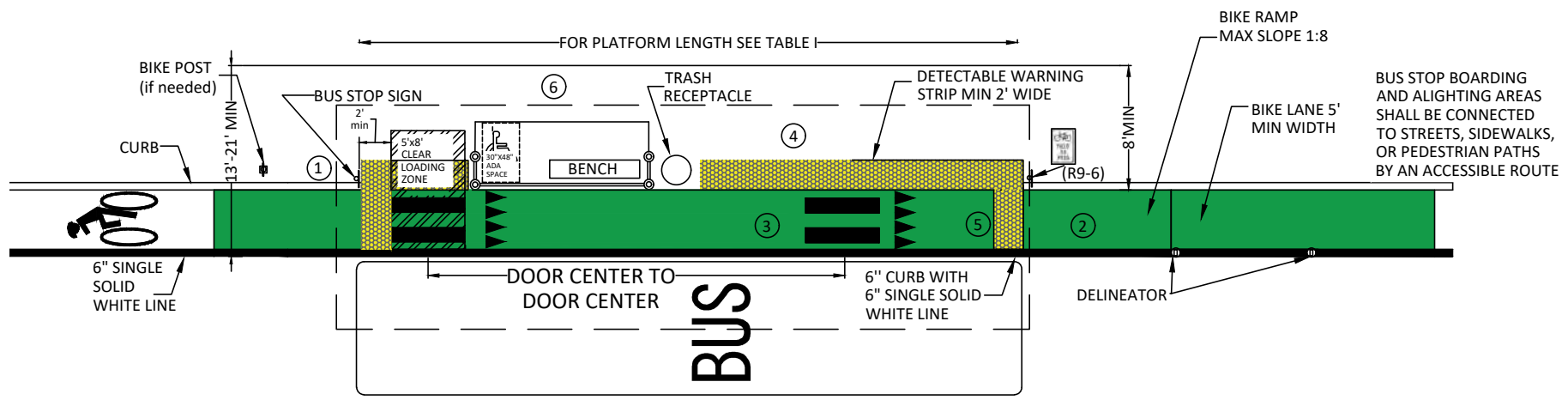
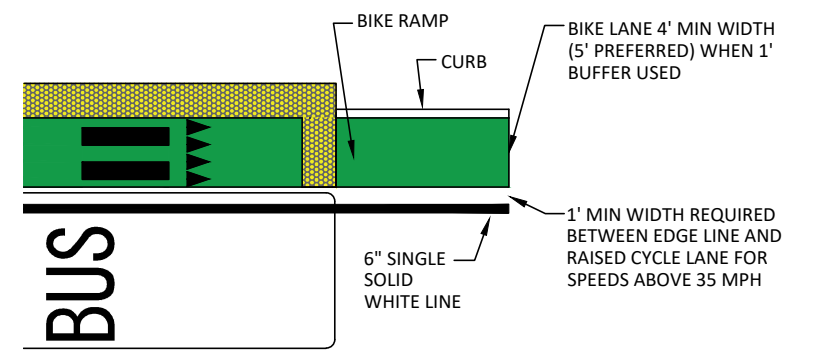

WEGO PUBLIC TRANSIT
STANDARD BUS STOP DESIGN GUIDELINES

EXCLUSIVE CYCLE LANE STOP

DRAWN BY: KYS
CHECKED BY:
DATE SEPT 2018

REVISIONS	
BY:	DATE:

PROJECT NO.	SHEET NO.
	8

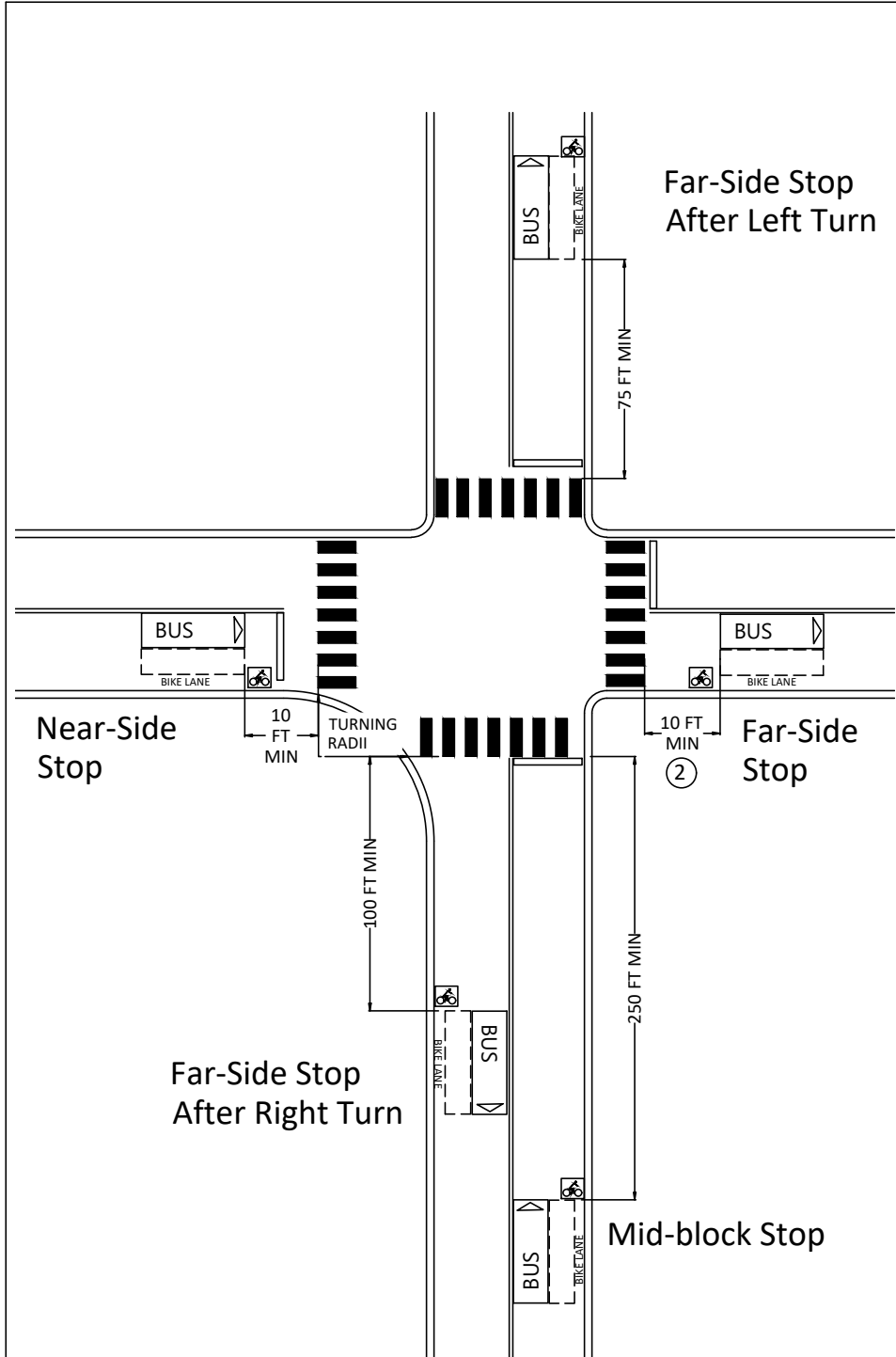

- GENERAL NOTES**
- (A) FOR SPECIFIC CONDITIONS NOT COVERED ON THIS SHEET, REFERENCE SHOULD BE MADE TO THE DESIGN GUIDELINES REPORT.
 - (B) DESIGN STANDARDS SHOWN IN THIS LAYOUT ARE REFERENCED FROM STATE OF TENNESSEE DEPARTMENT OF TRANSPORTATION AND NASHVILLE METRO PUBLIC WORKS STANDARD DRAWINGS, AS WELL AS 2010 ADA STANDARDS FOR ACCESSIBLE DESIGN. CURRENT STANDARDS SHOULD BE REVIEWED FOR COMPLIANCE BEFORE STOPS ARE INSTALLED OR MODIFIED.
 - (C) DESIGN GUIDELINES SHOWN IN THIS LAYOUT ARE REFERENCED FROM NACTO'S 2016 TRANSIT STREET DESIGN GUIDE AND THE TRANSIT COOPERATIVE RESEARCH PROGRAM REPORT 19 - GUIDELINES FOR THE LOCATION AND DESIGN OF BUS STOPS. CURRENT DESIGN GUIDELINES SHOULD BE REVIEWED FOR COMPLIANCE BEFORE STOPS ARE INSTALLED OR MODIFIED.
 - (D) ALL SIGNS, SYMBOLS, MARKINGS AND THEIR SPACING SHOULD ADHERE TO MUTCD, STATE AND LOCAL GUIDANCE.
 - (E) TO PREVENT THE BUS STOP SIGNS FROM BEING STRUCK BY MIRRORS, ALL SIGNS SHOULD BE A MINIMUM OF 24 INCHES (2 FEET) FROM THE FACE OF THE CURB.
 - (F) THE BUS STOP SIGN SHOULD BE LOCATED AT THE FRONT OF EACH BUS ZONE, TO LOCATE THE APPROXIMATE STOPPING POINT FOR THE FRONT OF THE BUS.
 - (G) THE 5'X8' ADA BOARDING AREA SHOULD ALIGN WITH THE WHEELCHAIR LOADING POSITION OF ANY BUS IN MTA'S FLEET THAT WOULD TYPICALLY BE ASSIGNED TO THAT ROUTE.

- FOOTNOTES**
- ① REFER TO SHEETS 1 AND 3 FOR SIGN AND SHELTER STANDARDS.
 - ② PROVIDE AT LEAST 10 FEET OF CLEAR DISTANCE FROM CROSSWALK OR CURB RETURN TO THE BUS. THE LENGTH MAY BE LONGER ON HIGH VOLUME AREAS TO ALLOW QUEUING ON FAR-SIDE STOPS.
 - ③ SEE TABLE I FOR BUS PLATFORM LENGTH.
 - ④ A MINIMUM CLEARANCE OF 60 INCHES (5 FEET) SHALL BE MAINTAINED FOR A CLEAR PATH AROUND BUS STOP ELEMENTS PER METRO PUBLIC WORKS AND WEGO STANDARDS
 - ⑤ REFER TO ADA, STATE AND LOCAL GUIDELINES FOR CURB RAMPS.
 - ⑥ DETECTABLE WARNING STRIPS MUST BE PLACED ON BOTH SIDES OF EVERY FLUSH CROSSING OVER THE BIKE LANE.
 - ⑦ BOLLARDS SHALL BE PROVIDED AT EACH SIDE OF THE ISLAND STOP.
 - ⑧ IF RAILING IS INSTALLED CONTINUOUSLY ALONG THE BACK OF THE PLATFORM THE ISLAND MUST BE 9 FEET TO ALLOW FOR 8 FEET BOARDING ACCESS.
 - ⑨ ADDITIONAL WIDTH BEYOND MINIMUM PLATFORM REQUIRED TO ACCOMMODATE BOLLARDS AND TAPER.

TABLE I : DESIRED MINIMUM PLATFORM LENGTH

STOP POSITION	40' BUS	60' BUS	2x40' BUS	2x60' BUS
NEAR-SIDE	35	55	80	115
FAR-SIDE	45	65	90	130
MID-BLOCK	35	55	80	115

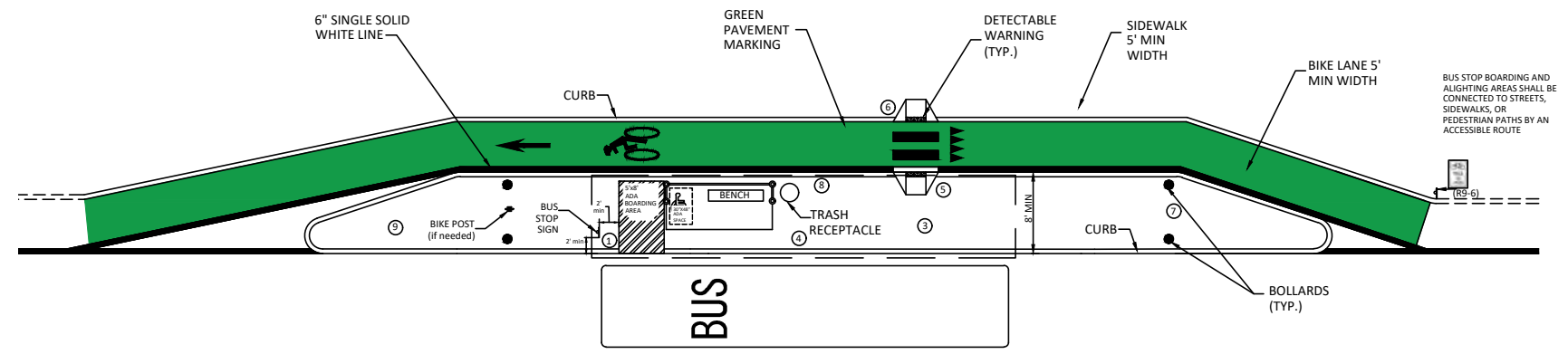

WEGO PUBLIC TRANSIT
STANDARD BUS STOP DESIGN GUIDELINES

BUS BOARDING ISLAND
CONFIGURATION A

DRAWN BY: KYS
CHECKED BY:
DATE: SEPT 2018

REVISIONS	
BY:	DATE:

PROJECT NO.	SHEET NO.
	9

© 2012 CDM SMITH ALL RIGHTS RESERVED. THESE DOCUMENTS AND DESIGNS PROVIDED BY PROFESSIONAL SERVICE, INCORPORATED HEREIN, ARE THE PROPERTY OF CDM SMITH AND ARE NOT TO BE USED, IN WHOLE OR PART, FOR ANY OTHER PROJECT WITHOUT THE WRITTEN AUTHORIZATION OF CDM SMITH.

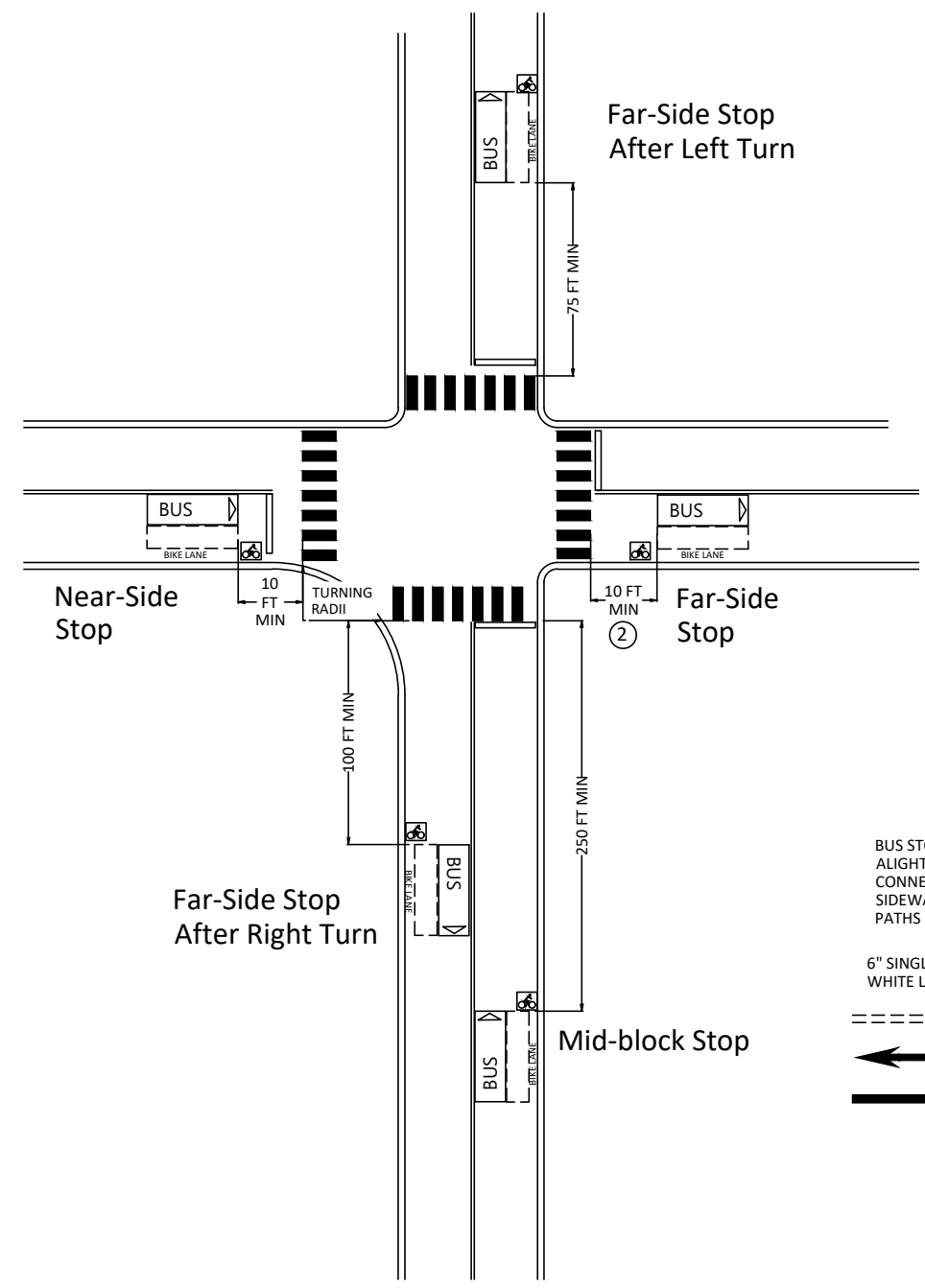

- GENERAL NOTES**
- (A) FOR SPECIFIC CONDITIONS NOT COVERED ON THIS SHEET, REFERENCE SHOULD BE MADE TO THE DESIGN GUIDELINES REPORT.
 - (B) DESIGN STANDARDS SHOWN IN THIS LAYOUT ARE REFERENCED FROM STATE OF TENNESSEE DEPARTMENT OF TRANSPORTATION AND NASHVILLE METRO PUBLIC WORKS STANDARD DRAWINGS, AS WELL AS 2010 ADA STANDARDS FOR ACCESSIBLE DESIGN. CURRENT STANDARDS SHOULD BE REVIEWED FOR COMPLIANCE BEFORE STOPS ARE INSTALLED OR MODIFIED.
 - (C) DESIGN GUIDELINES SHOWN IN THIS LAYOUT ARE REFERENCED FROM NACTO'S 2016 TRANSIT STREET DESIGN GUIDE AND THE TRANSIT COOPERATIVE RESEARCH PROGRAM REPORT 19 - GUIDELINES FOR THE LOCATION AND DESIGN OF BUS STOPS. CURRENT DESIGN GUIDELINES SHOULD BE REVIEWED FOR COMPLIANCE BEFORE STOPS ARE INSTALLED OR MODIFIED.
 - (D) ALL SIGNS, SYMBOLS, MARKINGS AND THEIR SPACING SHOULD ADHERE TO MUTCD, STATE AND LOCAL GUIDANCE.
 - (E) TO PREVENT THE BUS STOP SIGNS FROM BEING STRUCK BY MIRRORS, ALL SIGNS SHOULD BE A MINIMUM OF 24 INCHES (2 FEET) FROM THE FACE OF THE CURB.
 - (F) THE BUS STOP SIGN SHOULD BE LOCATED AT THE FRONT OF EACH BUS ZONE, TO LOCATE THE APPROXIMATE STOPPING POINT FOR THE FRONT OF THE BUS.
 - (G) THE 5'X8' ADA BOARDING AREA SHOULD ALIGN WITH THE WHEELCHAIR LOADING POSITION OF ANY BUS IN MTA'S FLEET THAT WOULD TYPICALLY BE ASSIGNED TO THAT ROUTE.

- FOOTNOTES**
- ① REFER TO SHEETS 1 AND 3 FOR SIGN AND SHELTER STANDARDS.
 - ② PROVIDE AT LEAST 10 FEET OF CLEAR DISTANCE FROM CROSSWALK OR CURB RETURN TO THE BUS. THE LENGTH MAY BE LONGER ON HIGH VOLUME AREAS TO ALLOW QUEUING ON FAR-SIDE STOPS.
 - ③ SEE TABLE 1 FOR BUS PLATFORM LENGTH.
 - ④ A MINIMUM CLEARANCE OF 60 INCHES (5 FEET) SHALL BE MAINTAINED FOR A CLEAR PATH AROUND BUS STOP ELEMENTS PER METRO PUBLIC WORKS AND WEGO STANDARDS
 - ⑤ REFER TO ADA, STATE AND LOCAL GUIDELINES FOR CURB RAMPS.
 - ⑥ DETECTABLE WARNING STRIPS MUST BE PLACED ON BOTH SIDES OF EVERY FLUSH CROSSING OVER THE BIKE LANE.
 - ⑦ BOLLARDS SHALL BE PROVIDED AT EACH SIDE OF THE ISLAND STOP.
 - ⑧ IF RAILING IS INSTALLED CONTINUOUSLY ALONG THE BACK OF THE PLATFORM THE ISLAND MUST BE 9 FEET TO PROVIDE 8 FEET OF BOARDING PLATFORM.
 - ⑨ ADDITIONAL WIDTH BEYOND MINIMUM PLATFORM REQUIRED TO ACCOMMODATE BOLLARDS AND TAPER.
 - ⑩ MAXIMUM OF 1:12 SLOPE FOR PLATFORM ACCESS RAMPS SHALL BE PROVIDED.

TABLE 1 : DESIRED MINIMUM PLATFORM LENGTH

STOP POSITION	40' BUS	60' BUS	2x40' BUS	2x60' BUS
NEAR-SIDE	35	55	80	115
FAR-SIDE	45	65	90	130
MID-BLOCK	35	55	80	115

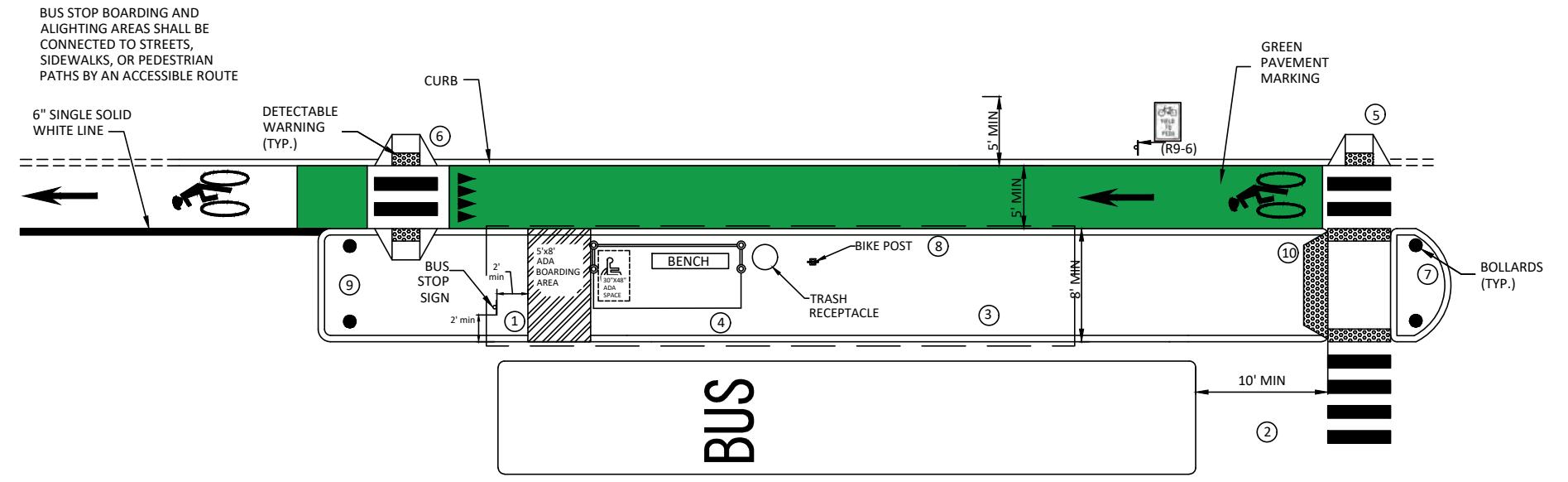

WEGO PUBLIC TRANSIT
STANDARD BUS STOP DESIGN GUIDELINES

BOARDING ISLAND STOP
CONFIGURATION B

DRAWN BY: KYS
CHECKED BY:
DATE SEPT 2018

REVISIONS	
BY:	DATE:

PROJECT NO.	SHEET NO.
	10